

MMH Scan™

Analysis + Definition of Barriers to Missing Middle Housing

Prepared for:
Knoxville, TN

**September 16,
2022**

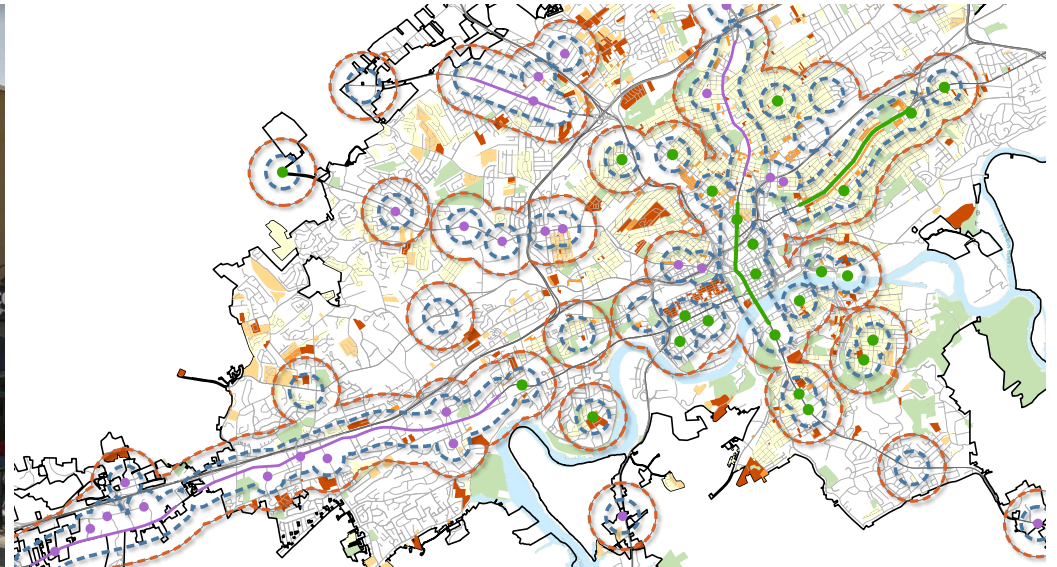

Prepared For:

**The City of Knoxville with generous support
from KAAR**

Prepared By:

Opticos Design, Inc.

2100 Milvia Street; Suite 125

Berkeley, California 94704

510.558.6957

Missing Middle Housing term created by Daniel
Parolek/Image © Opticos Design, Inc./For more
info visit www.missingmiddlehousing.com

What's Inside?

MMH Scan™ Analysis + Definition of Barriers to Missing Middle Housing

Chapter 1	Purpose + Objectives	5
	What This Study Is About	6
	Overview of Knoxville's Population + Housing	8
	Why Missing Middle Housing (MMH) is Important to the Future of Communities	10
Chapter 2	About Missing Middle Housing	13
	What Is Missing Middle Housing?	14
	What Is A Missing Middle Building Type?	20
	What Is A Frontage Type?	34
	Missing Middle Housing in Knoxville	36
	Walkable Centers in Knoxville	38
	Missing Middle Housing-Ready Neighborhoods	42
Chapter 3	Analysis of Barriers	51
	Comprehensive Plan	52
	Zoning Districts and Standards	56
	Summary of Barriers	66
	Allowed Density	68
	Minimum Lot Width	70
	Next Steps	72

Purpose + Objectives



In this chapter

What This Study Is About	6
Overview of Knoxville's Population + Housing	8
Why Missing Middle Housing (MMH) is Important to the Future of Communities	10

1.1

What This Study Is About

Knoxville is working to expand the variety of housing choice and promote affordability.

The Need for More Housing Choices

Increasingly, millennials and baby boomers are looking for more choices and smaller places to live that are within walking distance of their lifestyle. But the choices primarily continue to be single-family houses and large apartment projects.

The Need for Regulatory Change

Too often, the types and size of new dwellings that the market wants are not allowed by local policy or zoning regulations. This leaves innovative developments needing to go through complex and uncertain review processes when trying to respond to the shifting market. Regulatory change is needed to make new investment predictable and simple.

Missing Middle Housing (MMH) is intended to be part of low-rise residential neighborhoods, which are typically zoned as some variety of “single-family residential”. However, because MMH contains multiple units, it is, by definition, not allowed in single-unit zoning districts. But MMH is not the same as typical apartment projects either.

Typical multi-family zoning districts allow much bigger buildings (taller and wider) and also typically encourage lot aggregation and large suburban garden apartment buildings. The environments created by these zoning districts are not what is intended by MMH.

Focus of this Study

The scope of work provided for in-depth analysis of up to four zones across Knoxville. The City of Knoxville selected the following zones to study how these zones could contribute to generating MMH: RN-2, RN-3, RN-4, and RN-5. These zones were selected for two key reasons: how much they occur near existing and potential Walkable Centers, and because the allowed size of buildings in these zones best aligns with the house-scale nature of MMH.

Location of Available U.S. Housing Stock

90% of available housing in the U.S. is located in a conventional neighborhood of single-unit homes, adding up to a 35 million unit housing shortage.²

Based on the need for more housing and affordable housing choices, Knoxville is taking the leadership role to identify the barriers that hinder or prevent MMH. The results of this study and specific recommendations are in Chapter 3. These results and recommendations will benefit Knoxville most if pursued by a broad coalition of public and private sector groups and individuals working together.

Source

²Dr. Arthur C. Nelson "Missing Middle: Demand and Benefits", Utah ULI Conference, October 21, 2014

Note

In this analysis "single-family" is hereafter referred to as "single-unit."



Figure 1.1 An example of the Multiplex Small MMH type (Knoxville, TN)

1.2

Overview of Knoxville's Population + Housing

Population Projections Through 2040

Between 2010 and 2020 the population of the City of Knoxville increased by 6.6%, while the amount of new housing units only increased by 4.4%.

By 2040, Knoxville is projected to become home to an additional 14,369 residents. Using the average household size for Knoxville (2.18 people), that means an additional 6,591 units over the next 19

years, or an annual average of 347 units. In 2021, Knoxville produced 1,310 new units, of which 177 were single-unit dwellings. This trend is encouraging for multifamily housing. However, it is important to maintain particular attention on MMH types because of the possibility of this scale of housing being grouped with conventional multifamily development.

Population Characteristics	
Total Population ¹	192,648
Average Household Size ¹	2.18
Homeowners ¹	46.90%
Renters ¹	53.10%
Renter Vacancy Rate ²	6%
Median Household Income ¹	\$41,598
Median Home Value ³	\$310,000
Median Monthly Rent ¹	\$833
Total Amount of Land ¹	98.7 sq. miles
Amount of Land Zoned for multi-family Housing ²	4.65% (3,100 acres)

¹ U.S. Census

² City of Knoxville

³ Redfin

Housing Types (Existing) ¹		
	Total	%
Single-unit, Detached	49,539	53.6%
Single-unit, Attached ⁴	4,701	5.1%
Duplexes	2,391	2.6%
Buildings with 3-4 Units ⁵	4,560	4.9%
Buildings with 5-9 Units ⁵	7,202	7.8%
Buildings with 10-19 Units ⁵	10,499	11.4%
Buildings with >20 Units	12,266	13.3%
Mobile Homes	1,157	1.3%
Other ⁶	79	0.1%
Total:	92,394	100%

⁴ Includes Townhouses

⁵ May include some MMH types

⁶ Dorms, Fraternities/Sororities, Other Institutional units

Key



















-  Slope Protection Area
-  Stream Protection Area
-  Public Parks & Open Space
-  Other Open Space
-  Landscaped Corridor
-  Agricultural/Rural Residential
-  Low Density Residential
-  Medium Density Residential
-  High Density Residential
-  Mixed Uses
-  Commercial
-  Office
-  Public Institutional
-  Light Industrial
-  Heavy Industrial
-  Technology Park
-  Business Park
-  Transportation
-  Water

Figure 1.3 Future Land Use Map of Knox County



1.3

Why Missing Middle Housing (MMH) is Important to the Future of Communities

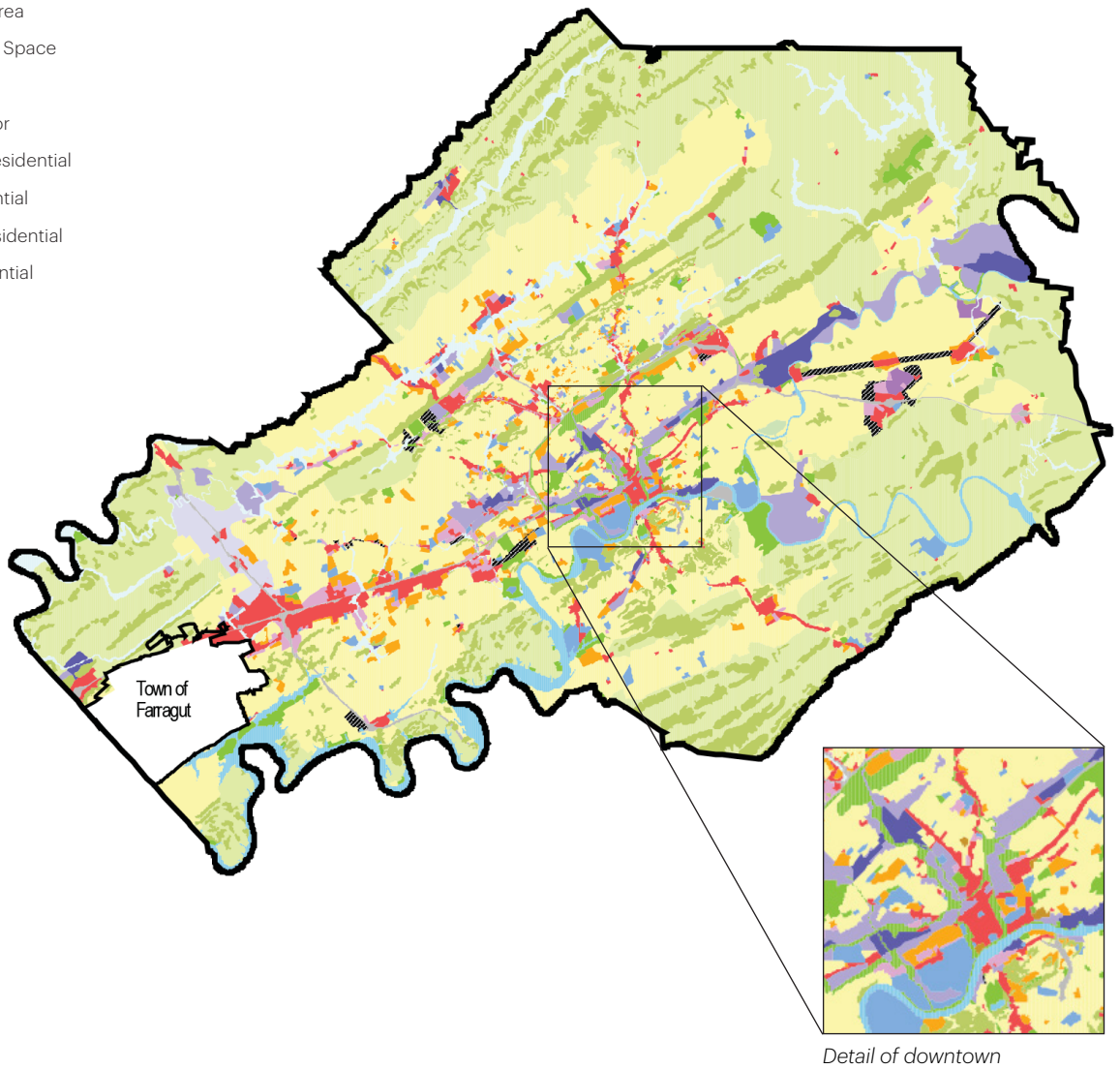
Eight key national trends point to MMH as an essential part of communities' strategy for reinvestment and housing production.

Sources

¹National Association of Realtors

²American Planning Association

Cities Are Prioritizing Walkability for Their Triple-bottom-line Benefits

- The improved physical and mental health of residents;
- Environmental stewardship; and
- Economic benefits.

Walkable Living in Demand

- There is a 20-35% gap between the demand and supply of walkable urban living choices. Essentially two housing products, single-unit houses and mid/high-rise apartments, are creating the gap, and
- 60% of people favor neighborhoods with a walkable mix of houses and stores rather than neighborhoods that require more driving between home, work, and play.¹

Housing Choices Have Been at Extreme Ends of The Spectrum

For the past 75 years, we have primarily been building detached single-unit houses and mid-rise/high-rise apartments, without addressing the market needs between these two ends.

Millennials and Baby Boomers²

- 56% of millennials and 46% of baby boomers want to live in more Walkable Neighborhoods, and
- 59% of millennials and 27% of baby boomers are looking for MMH.

Office Tenants³

Office tenants prefer locations in walkable environments over typical suburban office parks by a ratio of 4 to 1.

Changing Demographics⁴

By 2025, 85% of households will not have children, but we are building as if they will. Millennials, baby boomers, and single person households do not need or want a large yard or house to maintain. Further, nearly 30% of them are single-person households.

10,000 Baby Boomers Retire Every Day⁵

Half of them have no retirement savings and depend on their social security payment (avg. \$1,341 per month), requiring smaller and more affordable housing choices.

Shortage of 3.8 Million Units

Across the U.S., we are short of the demand for small lot and attached housing units.⁶

Sources

- ³NAIOP Commercial Real Estate Development Association
- ⁴U.S. Census Bureau
- ⁵Home.one
- ⁶Freddy Mac

Figure 1.4 Housing type preferences of Baby Boomers and Millennials²

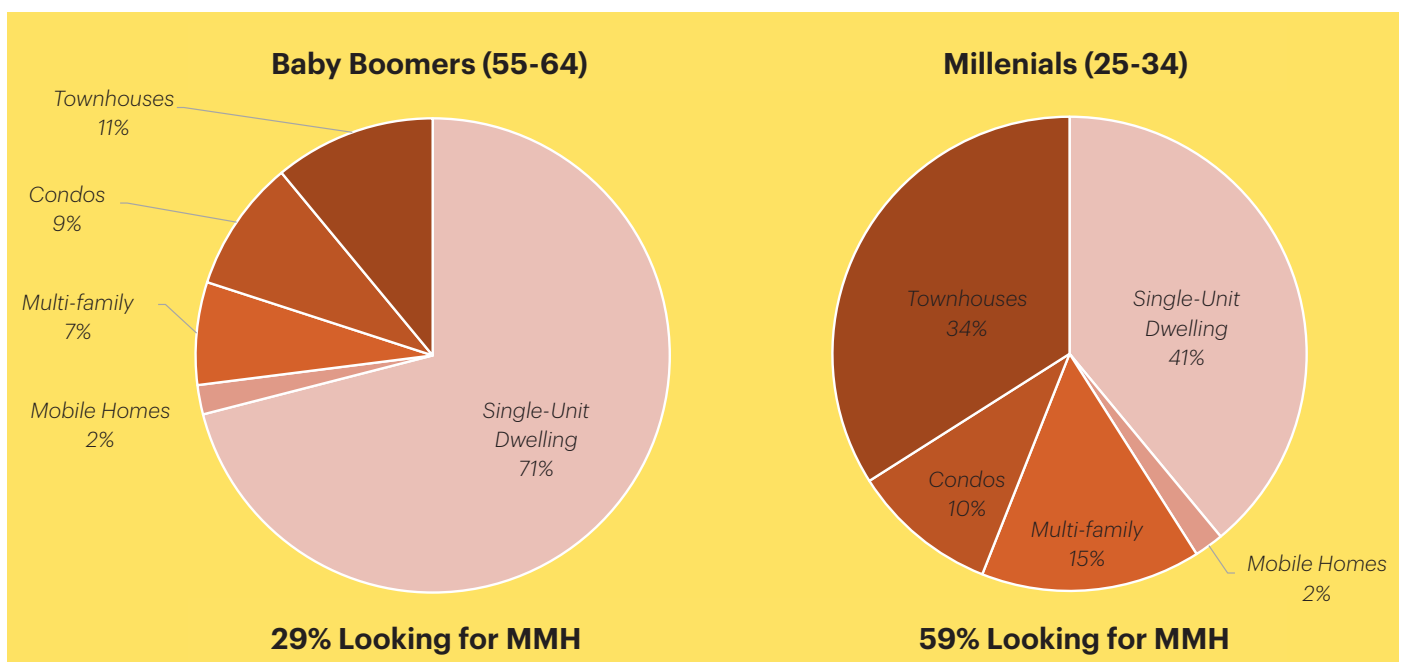

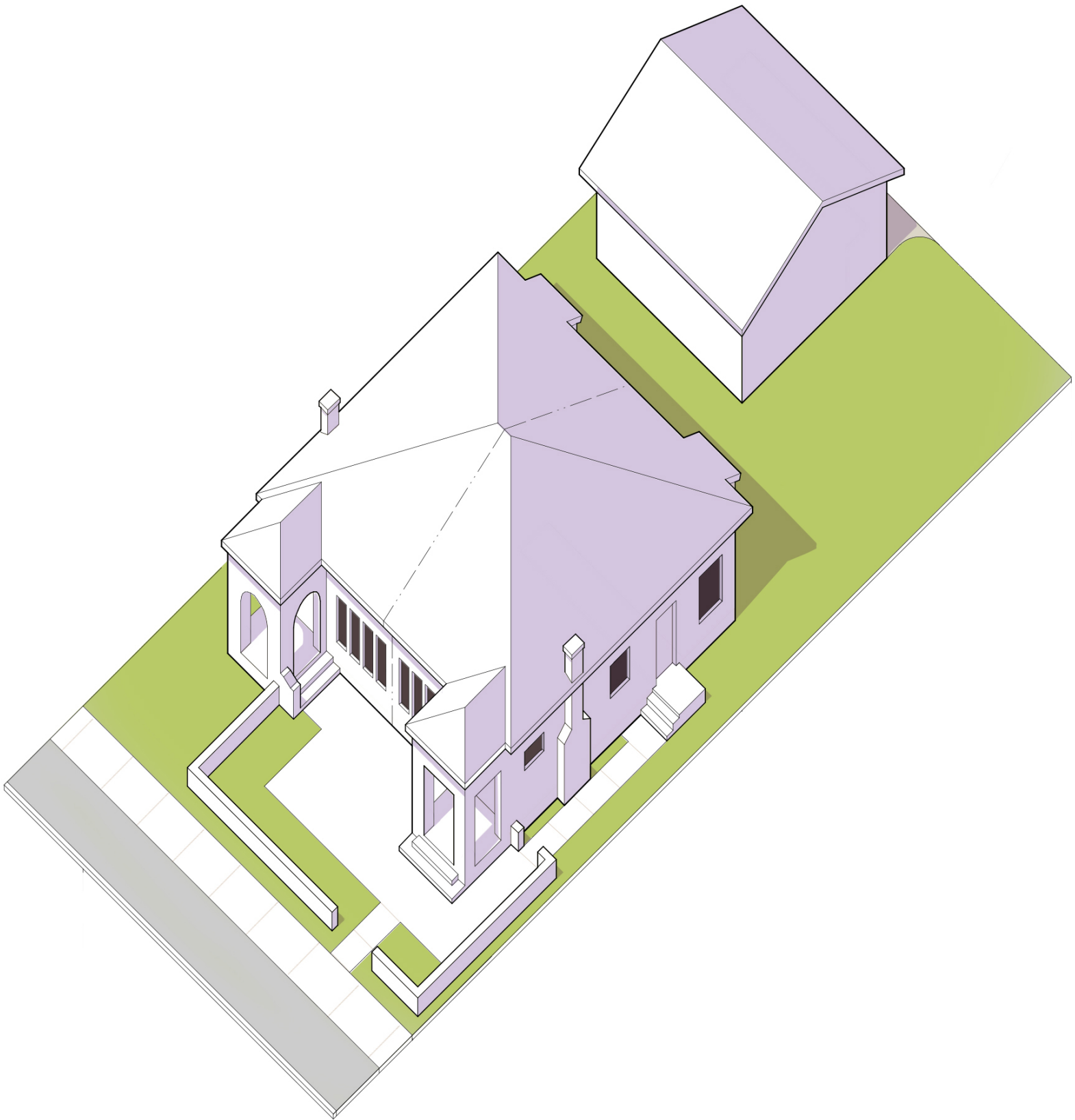

About Missing Middle Housing

CHAPTER

2

In this chapter

What Is Missing Middle Housing?	14
What Is A Missing Middle Building Type?	20
What Is A Frontage Type?	34
Missing Middle Housing in Knoxville	36
Walkable Centers in Knoxville	38
Missing Middle Housing-Ready Neighborhoods	42

2.1

What Is Missing Middle Housing?

House-scale buildings with multiple units in Walkable Neighborhoods

Responding to The Demand for Walkable Urban Living

The mismatch between current US housing stock and shifting demographics, combined with the growing demand for walkable urban living, has been poignantly defined by recent research and publications by Christopher Nelson and Chris Leinberger, and most recently by the Urban Land Institute’s publication “What’s Next: Real Estate in the New Economy.”

The solution is not as simple as adding more multi-family housing stock using the same housing typologies that have been built over the past couple of decades. Instead, it will be necessary to shift the way that we design, locate, regulate, and develop homes. As “What’s Next” states, “It’s a time to rethink and evolve, reinvent

and renew.” To that end, MMH types such as Duplexes, Fourplexes, Cottage Courts, Multiplexes, Townhouses, and Live/Work units, are a critical part of the solution and should be in the toolbox of every architect, planner, real estate agent, and developer.

Well-designed and simple, Missing Middle types achieve medium-density yields and provide high-quality, marketable options between the scales of single-unit homes and mid-rise apartments. They are designed to meet the specific needs of shifting demographics and new market demands and are a key component in neighborhoods offering diverse housing choices. They are called “missing” because very few of these

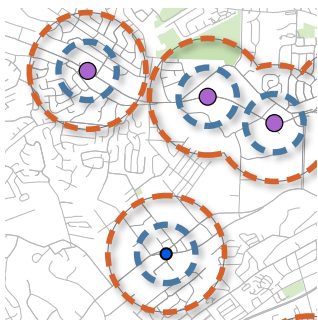

Figure 2.1 Walkable Neighborhoods within a 5-minute walk (blue dashed area) and 10-minute walk (orange dashed areas) or 5-minute bike ride surrounding a variety of Walkable Centers.

Q CLOSER LOOK

Walkable Neighborhood

These are places where a person can easily walk or bike to home, work, or to fulfill most daily needs, including shopping and recreation. The compact form and mix of uses found in a Walkable Neighborhood are anchored by “Walkable Centers”: where neighborhood-serving retail, food, services, and employment are located in a pedestrian-oriented

environment, affording multi-modal access throughout the area. These environments accommodate but do not depend on the use of automobiles for most daily needs. This was the standard model developed prior to the 1940s. See Section 2.3 for more information on “Walkable Centers”.



housing types have been built since the early 1940s due to regulatory constraints, the shift to auto-dependent patterns of development, and the incentivization of single-unit homeownership by the federal government. Before the 1940s, they were a natural part of the housing mix, helping to provide housing choices to people at a variety of stages in their life and income levels. Communities and organizations, including AARP, are realizing that MMH is important in helping neighborhoods thrive while providing housing choices as people age and can stay in their neighborhood.

A Walkable Context

A critical characteristic of the MMH types is that they are most effective when located within an existing or newly created walkable context. Buyers or renters of these housing types are choosing to trade larger suburban housing for less space, less yard to maintain, and proximity to amenities such as restaurants, bars, markets, services, and employment. Figure 2.1 shows potential “walkable” areas in Knoxville surrounding mixed-use “centers” that are not car-dependent.

Medium-density but Lower Perceived Densities

Missing Middle building types typically range in density from about 10 dwelling units per acre (du/acre) to up to 50 or 60 du/acre, depending on the building type and lot size. It is important not to

get distracted with the density numbers when thinking about these types. Density is an unpredictable factor that depends on many variables; see Figures 2.2 and 2.3 as an example. Due to the small footprint of MMH types, and the fact that they are usually mixed with a variety of building types, even on an individual block, their perceived density is usually quite low—they do not look like dense buildings.

A combination of these types provides a neighborhood with a minimum average of 16 du/acre. This is generally the threshold at which an environment has enough people to be transit-supportive and when neighborhood-serving, walkable retail, and services become viable.

Small Footprint and Blended Densities

A common characteristic of these housing types is their small-to-medium-sized building footprints. The largest of the Missing Middle types have a typical main body width of about 40 to 60 feet and can be up to 75 feet overall when secondary wings are included. These sizes are comparable to a large estate home. This makes these types ideal for urban infill and complete neighborhoods, even in older neighborhoods that were originally developed as single-unit but could be designated to allow slightly higher intensities.

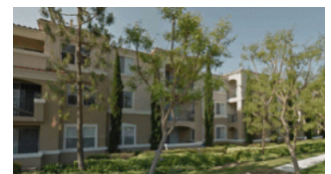

Figure 2.2
 - 49 units
 - 30 du/acre
 - 175' x 165' footprint
 - 3 Stories

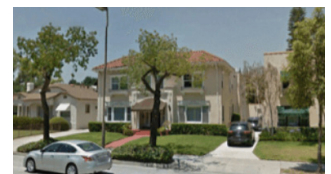

Figure 2.3
 - 5 units
 - 29 du/acre
 - 40' x 60' footprint
 - 2 Stories

Smaller, Well-designed Units

A common mistake by architects or builders new to the urban housing market is trying to force suburban unit types and sizes into urban contexts and housing types. The starting point for MMH is smaller-unit sizes (500 to 1,000 square feet). The challenge is to create small spaces that are well designed, comfortable, and usable. As an added benefit, smaller-unit sizes can help developers keep their costs down, improving the proforma performance of a project, while keeping the housing available to a larger group of buyers or renters at a lower price point.

Off-street Parking Does Not Drive The Site Plan

Trying to provide too much on-site parking can make a MMH project not viable. If large parking areas are provided or required, these buildings become very inefficient from a development potential or yield standpoint. As a starting point, these units should provide no more than one off-street parking space per unit. A good example of this is newly constructed MM neighborhood in Papillion, NE. To enable these lower off-street parking requirements, on-street parking is required to be available adjacent to the units. Housing design that forces too much on-site parking also compromises the occupant's experience of entering the building or "coming home" and the relationship with its context, especially in an infill condition, which can greatly impact marketability.

Figure 2.4 *The simple forms, smaller size, and compatibility with wood-frame construction help maximize affordability and investment returns, and are consistent with the construction strategies familiar to most residential homebuilders, as shown in this under-construction MMH project in Papillion, Nebraska.*



Simple Construction

“What’s Next” states, “Affordability—always a key element in housing markets—is taking on a whole new meaning as developers reach for ways to make attractive homes within the means of financially constrained buyers.” Because of their simple forms, smaller size, and Type V construction, Missing Middle building types can help developers maximize affordability and returns without compromising quality by providing housing types that are simple and affordable to build.

Creating Community

MMH creates community through the integration of shared community spaces within the types, as is the case for Courtyard Buildings or Cottage Courts, or simply from the proximity they provide to the community within a building and/or the neighborhood. This is an important aspect, in particular within the growing market of single-person households (which is at nearly 30% of all households, nationally) that want to be part of a community. This has been especially true for single women who have proven to be

a strong market for these MMH types, in particular Cottage Courts.

Marketability

A final critical characteristic is that these housing types are very close in scale to single-unit homes and provide a similar user experience. For example, in these types, you enter through a front porch facing the street instead of walking down a long corridor or anonymous stairway to get to your unit. This makes the mental shift for potential buyers and renters much less drastic than making a shift to live in a large apartment building. This, combined with the fact that many baby boomers likely grew up in or near to similar housing types in urban areas or had relatives that did, enables them to easily relate to these housing types.

This is a call for architects, planners, real estate professionals, and developers to think outside the box and to begin to create immediate, viable solutions to address the mismatch between the housing stock and what the market is demanding: vibrant, diverse, sustainable, walkable urban places. MMH types are an important part of this solution and should

be integrated into comprehensive and regional planning, zoning code updates, TOD strategies, and business models for developers and builders who want to be at the forefront of this paradigm shift.

Upper Missing Middle Housing

Upper Missing Middle Housing (Upper MMH) is the category of multi-unit buildings taller and deeper than MMH that still fit on the size of lots you would find in a single-unit neighborhood.

Upper MMH builds on MMH. By selecting strategic locations, it's still compatible with house-scale neighborhoods while likely achieving higher financial feasibility than

MMH. The Following are best practices to consider when using Upper MMH:

- Most effective where a greater degree of change is happening or desired.
- Use in transition areas of a neighborhood, connecting to more intense nodes or transit centers.
- Allow more lot coverage and/or deeper building footprints than for MMH.
- Require rear setback based on size of neighboring rear setbacks (up to 20 feet maximum)
- Reduced total stories along rear adjacent to neighboring houses.

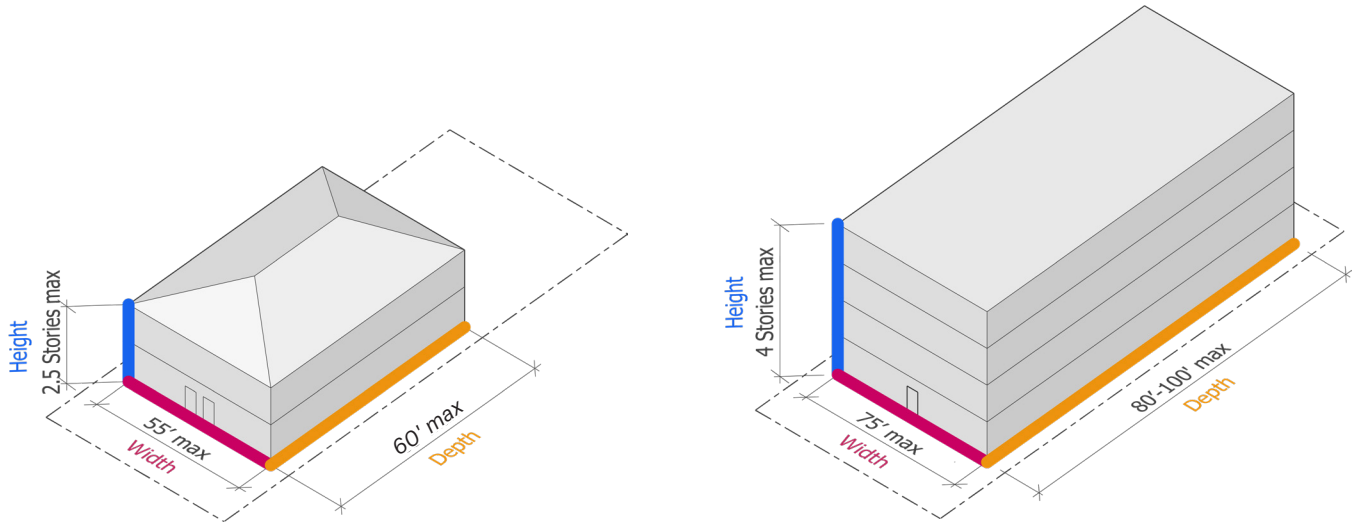

Figure 2.5 Example of where to consider locating Upper MMH in a neighborhood and along a corridor.

Key

-  Concentrate ground floor shops, services, food uses along major corridor
-  Upper MMH along major corridor as transition to adjacent low intensity neighborhood
-  Upper MMH secondary locations in response to ongoing change or desire for change

Figure 2.6 The diagrams and images below show a comparison between MMH and Upper MMH.



Missing Middle Housing (MMH)

Located within and along edges of low-to-moderate intensity neighborhoods.

Note: Wings not shown but allowed.

Upper Missing Middle Housing (Upper MMH)

Located along corridors and edges of neighborhoods where substantial change is happening or desired.



Duplex Side-by-Side (MMH)

2 units
Knoxville, TN



Multiplex Large (Upper MMH)

18+ units
Knoxville, TN

2.2

What Is A Missing Middle Building Type?

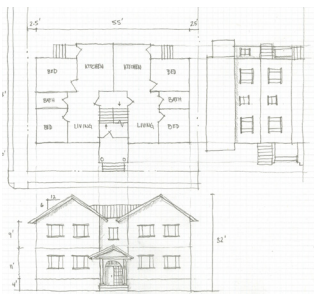

Figure 2.7 MMH walking tour (top) and example documentation of a MMH type observed during the tour (bottom)

Why Building Types Are Important for MMH

In order for MMH types to fit within the physical form of residential neighborhoods, it is important to understand the elements of building form and design that promote a house-scale look and feel. Building types provide a way to establish a common vocabulary that promotes house-scale building design. By providing this high degree of specificity, it is possible to promote more predictable outcomes in terms of what gets built. Higher degrees of predictability make it easier for the community to support new development projects since clear expectations in terms of building form can be set at the beginning of the development project.

Q CLOSER LOOK

How to Identify MMH Building Types in Knoxville

Taking an inventory of existing MMH types is the first step in creating building type standards. Many Missing Middle types may be non-conforming with existing zoning, or may have been converted into other uses, such as a single-unit home or offices, so it's important to do on-the-ground research to avoid overlooking existing examples. Mailboxes, electrical and gas meters, and window type/composition on the facade can indicate a Missing Middle type.

Existing Missing Middle types can provide guidance for calibrating zoning standards. Measuring lot dimensions, building footprints, frontage details, parking configurations, building height, location of units within the buildings, and location of building and/or unit entrances can help to define the unique characteristics of MMH types in Knoxville. Photo documentation also helps to inform standards, as well as providing examples of intended building form and character that can inform new development and infill development.

Characteristics of Missing Middle Building Types¹

Missing Middle Housing is not a new type of building. It is a range of house-scale building types that exist in cities and towns across the country. These types were a fundamental part of pre-1940s neighborhoods, and many examples exist in Knoxville's more historic neighborhoods.

All MMH types share the following characteristics:

- **Height.** Two to two and a half stories maximum (third story as an exception; only allow Upper MMH with careful consideration of form and scale impact, see pages 18-19).
- **Multiple units per building.** Maximum of twenty units in largest MMH type; typically 12 units or less per building
- **Footprint.** Typical main body width of 40 to 60 feet along the street and can be up to 75 feet overall when secondary wings are included.

- **Off-street parking.** Recommend requiring no more than one off-street parking space per unit. This is based on being near to services, retail, and the availability of on-street parking. Detached garage buildings can help to maintain house-scale for the primary building in neighborhoods with narrower houses.

- **On-site open space.** Private open space is not needed and should not be required. Shared open space exists in the most intense MMH types (Multiplex Large, Courtyard) in the form of a rear yard, sometimes as a wide side yard, or a courtyard.

- **Driveways.** Generally, driveway design for MMH types should match the neighborhood context on a per-lot basis. If no alley is present, single-wide driveways are recommended when possible to avoid building frontages dominated by parking.

Sources

¹*Missing Middle Housing, Thinking Big and Building Small to Respond to Today's Housing Crisis, Dan Parolek, Island Press*

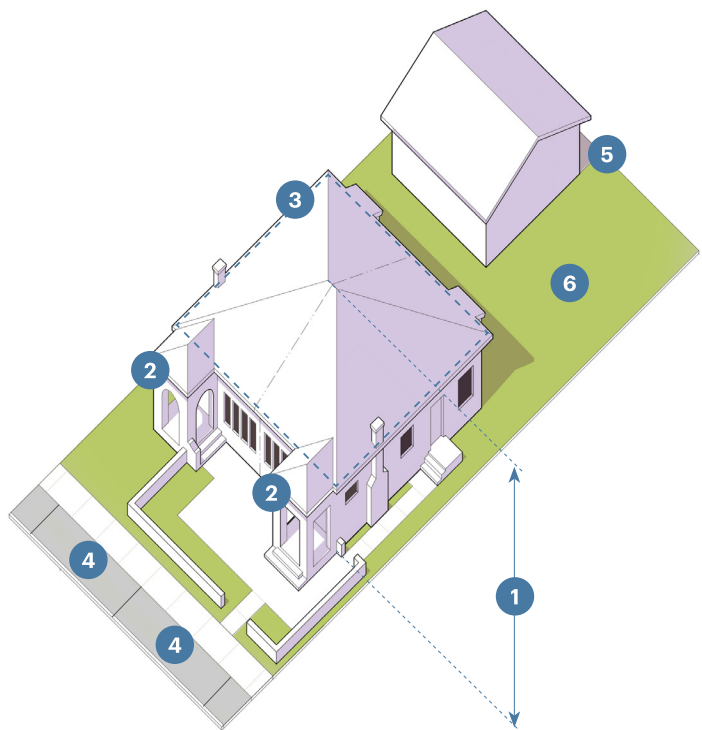

Figure 2.8 Important features to regulate

Key

- 1 Max. Height
- 2 Number of Units
- 3 Footprint/ Main Body Dimensions
- 4 On-street Parking
- 5 Driveways (if any)
- 6 On-site Open Space

Duplex Side-by-Side

Description

A small- to medium-sized building that consists of two dwelling units, one next to the other, both of which face and are entered from the street.

A variation of this is the "front-to-back" Duplex. This variation and the side-by-side building type are meant to provide two units within the footprint of a single-unit building. These are distinct from the non-recommended practice of attaching two single-unit houses to form two attached units. This latter approach often results in a building that is larger and is out of scale with its single-unit neighbors.



Accessory Dwelling Unit (ADU)

The ADU can be located above the garage building to provide an additional unit separate from the main building.

2

Duplex Side-by-Side		
Number of Units	Vehicular Access	
	Front	Rear
Lot Width (ft)	50' - 55'	45'
Lot Depth (ft)	100' - 150'	100'
Resultant Density (du/acre)		
Without ADU	11 - 17.4	19.4
With ADU	15.8 - 26.1	29

Duplex Stacked

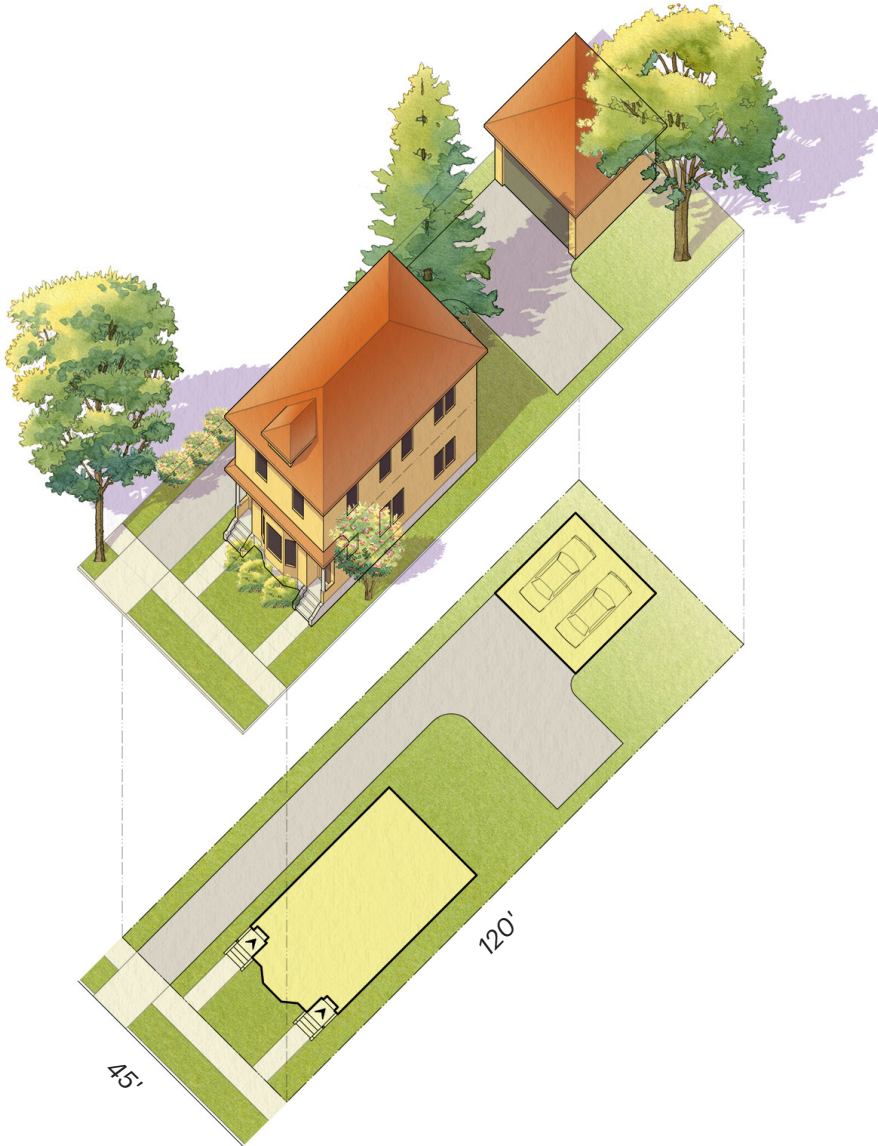

Description

A small- to medium-sized building that consists of two stacked dwelling units, one on top of the other, both of which face and are entered from the street.



Accessory Dwelling Unit (ADU)

The ADU can be located above the garage building to provide an additional unit separate from the main building.

Duplex Stacked			
Number of Units	Vehicular Access		
	Front	Rear	
Lot Width (ft)	45' - 50'	45'	
Lot Depth (ft)	100' - 130'	100'	
Resultant Density (du/acre)			
Without ADU	13 - 25	19.4	
With ADU	20.1 - 26.1	29	

2

Cottage Court/Bungalow Court

Description

A series of small, detached buildings on a lot arranged to define a shared court that is typically perpendicular to the street. The shared court takes the place of a private rear yard and is an important community-enhancing element.

The Accessory Dwelling Unit (ADU) is not recommended for this type due to the limited number of available off-street parking spaces.

A larger version of this type is known as the "Pocket Neighborhood". This type differs from the Cottage Court primarily by site size. Typically, the Pocket Neighborhood is on a site at least twice as large as the Cottage Court, has larger dwellings and a variety of housing types (Houses, Duplexes, etc.).



Cottage Court/ Bungalow Court		
Number of Units	Vehicular Access	
	Front	Rear
Lot Width (ft)	110' - 115'	105'
Lot Depth (ft)	205'	160'
Resultant Density (du/acre)		
Without ADU	15 - 19	28.5
With ADU	n/a	n/a

3-10

Triplex/Fourplex

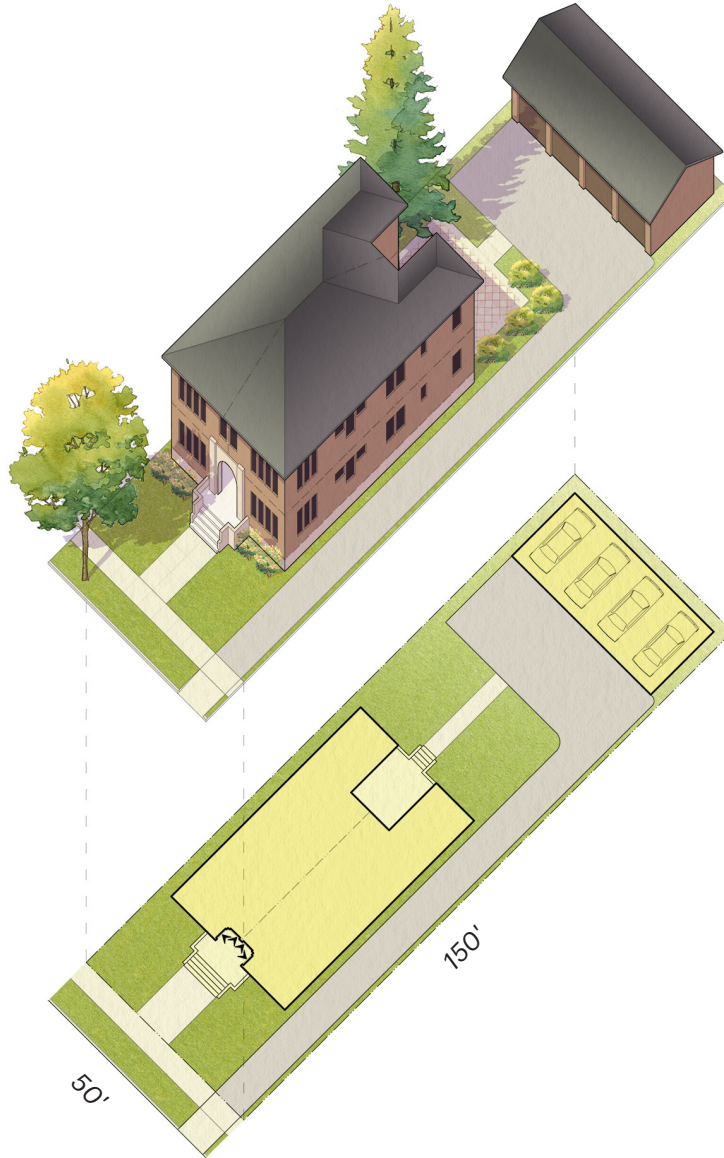

Description

A medium-sized building that consists of three to four units: typically two on the ground floor and up to two above with a shared entry from the street.



Accessory Dwelling Unit (ADU)

The ADU can be located above the garage building to provide an additional unit separate from the main building.

Triplex/Fourplex		
Number of Units	Vehicular Access	
	Front	Rear
3-4	Lot Width (ft)	50' - 60'
	Lot Depth (ft)	110' - 150'
	Resultant Density (du/acre)	
	Without ADU	20 - 29
	With ADU	25.9 - 31.7

Multiplex Small

Description

A medium-sized building that consists of 5 to 10 side-by-side and/or stacked dwelling units, typically with one shared entry or individual entries along the front and sometimes along one or both sides.

The Accessory Dwelling Unit (ADU) is not recommended for this type due to the limited number of available off-street parking spaces. In some situations, this type provides 0.5 parking spaces per unit at the lower end of the range of units.

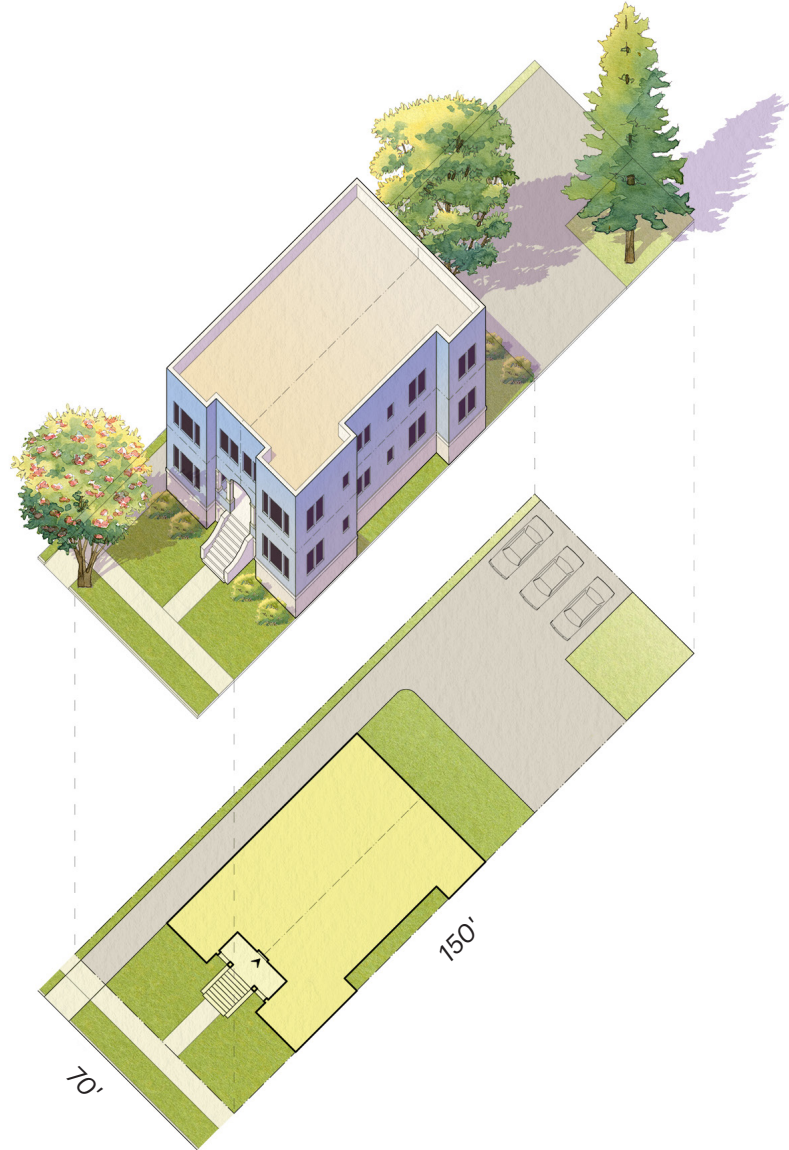

Multiplex Small			
Number of Units	Vehicular Access		
		Front	Rear
5-10	Lot Width (ft)	70' - 75'	65'
	Lot Depth (ft)	110' - 150'	110'
	Resultant Density (du/acre)		
	Without ADU	33.3 - 44.6	60.9
	With ADU	n/a	n/a

Multiplex Large (Mansion)



Description

A medium-to-large-sized 2- to 3-story structure that consists of 7 to 18 side-by-side and/or stacked dwelling units, typically with one shared entry or individual entries along the front and sometimes along one or both sides. In Upper MMH applications, this type generates at least 18 units and is up to 4 stories.

The Accessory Dwelling Unit (ADU) is not recommended for this type due to the limited number of available off-street parking spaces. In some situations, this type provides 0.5 parking spaces per unit at the lower end of the range of units.

Multiplex Large (Mansion)			
Number of Units	Vehicular Access		
	Front	Rear	
7-18	Lot Width (ft)	70' - 105'	65'
	Lot Depth (ft)	115' - 135'	115'
	Resultant Density (du/acre)		
	Without ADU	37 - 55.3	69.9
	With ADU	n/a	n/a

Courtyard Building

Description

A medium- to large-sized building or up to three small-to-medium size detached buildings consisting of multiple side-by-side and/or stacked dwelling units arranged around a shared courtyard. Dwellings are accessed from the courtyard. Typically, each unit has its own individual entry or shares a common entry with up to three units.

The Accessory Dwelling Unit (ADU) is not recommended for this type due to the limited number of available off-street parking spaces.

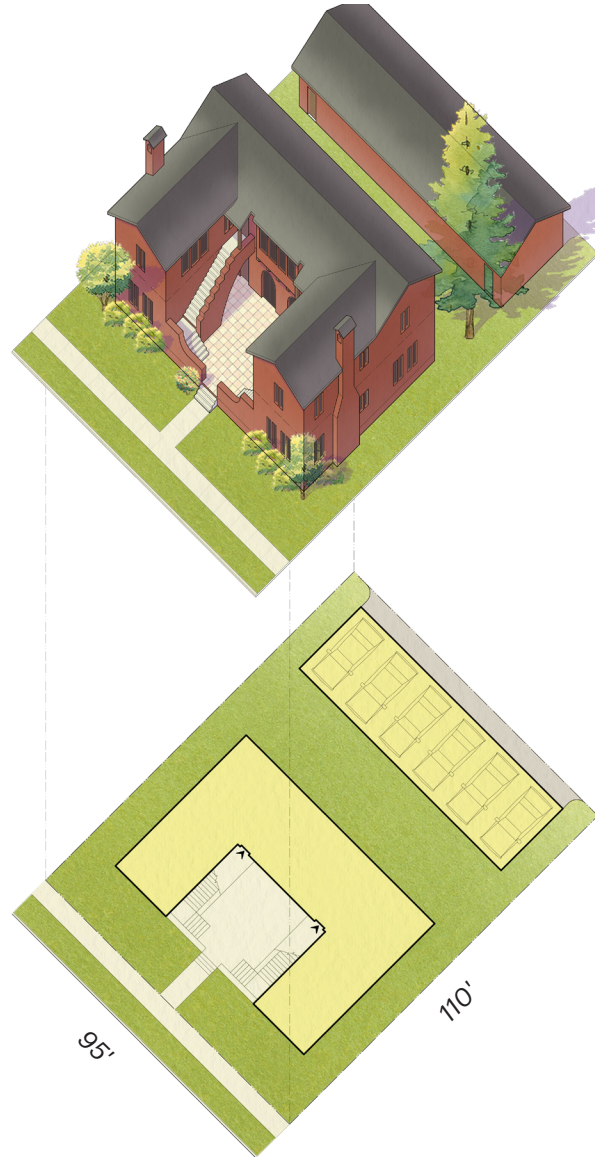

Courtyard Building			
Number of Units	Vehicular Access		
	Front	Rear	
6-20	Lot Width (ft)	100' - 125'	95'
	Lot Depth (ft)	110' - 150'	110'
Resultant Density (du/acre)			
	Without ADU	18 - 46.5	88
	With ADU	n/a	n/a

Townhouse Small

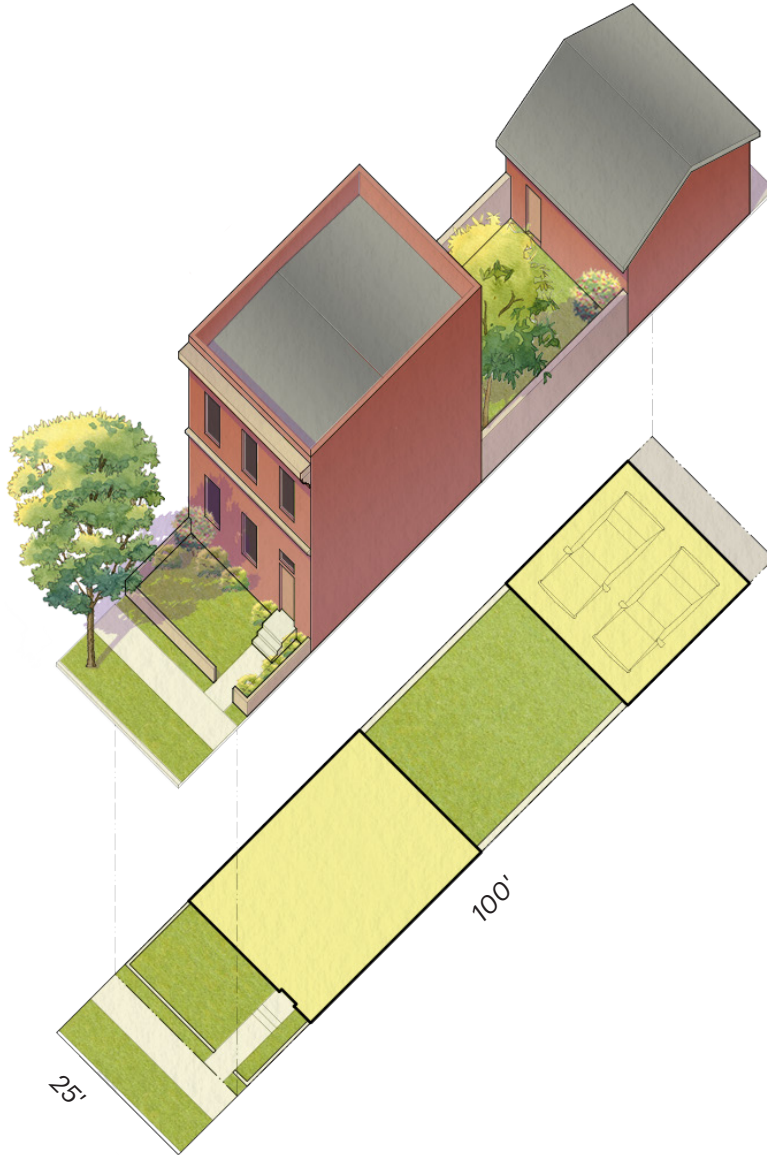

Description

A small- to medium-sized building with one dwelling that is attached to other Townhouses in an array of up to four, depending on the context.

Townhouse Small			
Number of Units	Vehicular Access		
	Front	Rear	
1	Lot Width (ft)	n/a	18' - 25'
	Lot Depth (ft)	n/a	100'
	Resultant Density (du/acre)		
	Without ADU	n/a	16 - 17.5
	With ADU	n/a	29 - 35

Townhouse Large

Description

A medium-sized 3-story building with one dwelling unit that is attached to other Townhouses in an array of more than four.

A more intense version of this type is the “Townhouse Flat” that divides the building vertically into two to three flats, depending on the context.

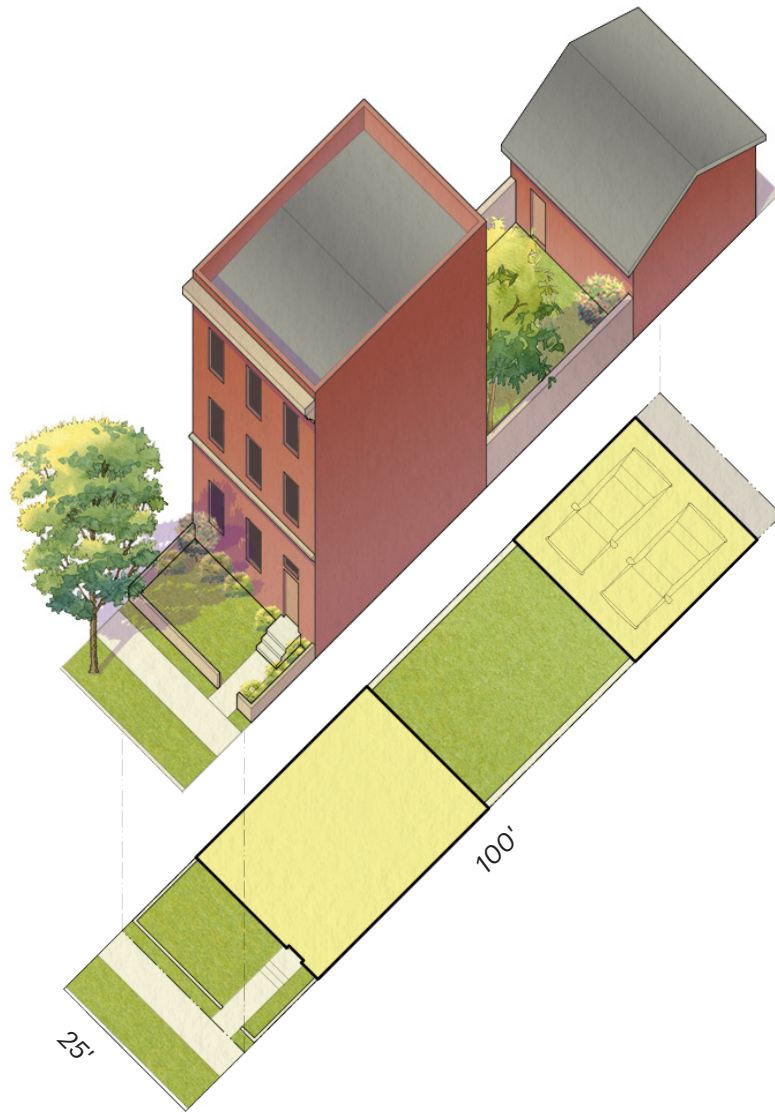

Townhouse Large			
	Number of Units	Vehicular Access	
		Front	Rear ¹
1	Lot Width (ft)	n/a	18' - 25'
	Lot Depth (ft)	n/a	100'
	Resultant Density (du/acre)		
	Without ADU	n/a	18.6 - 55.82
	With ADU	n/a	37.2 - 74.4

¹ Reflects one unit per Townhouse; however, option to design with one unit per floor, up to 3 units.

² This range reflects one to three units.

House-Scale Buildings

Main body only

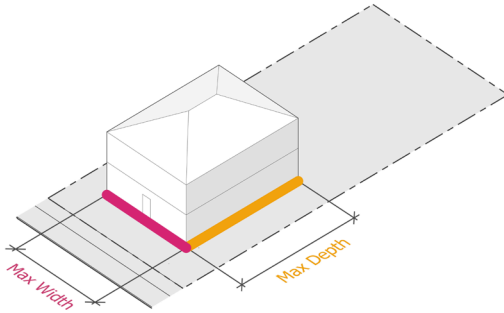

Main body with side and rear wings

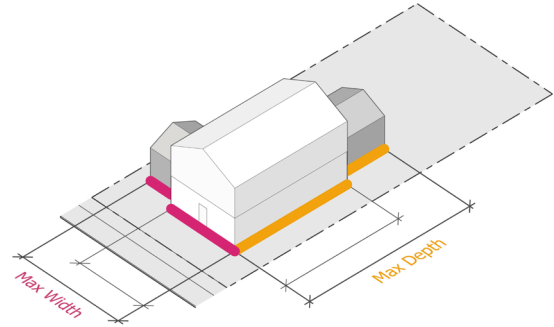

Block-Scale Buildings

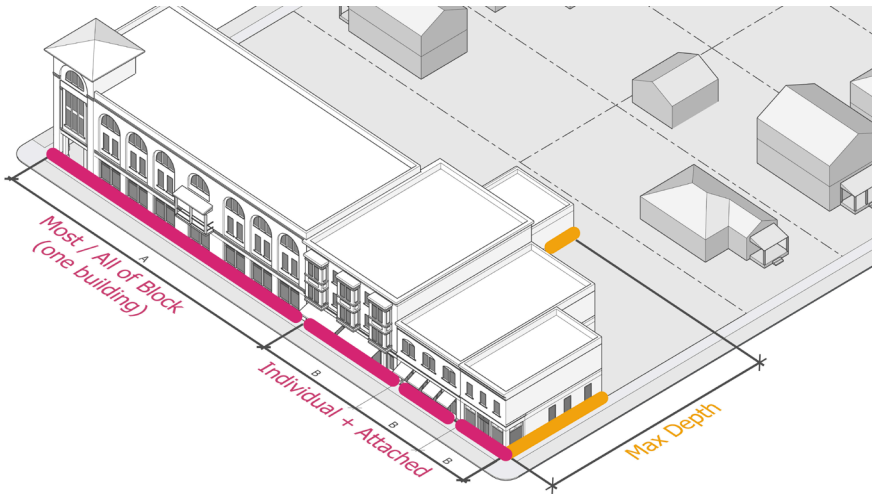

Q CLOSER LOOK

Building Type Categories

Building types fall into one of two categories: House-Scale and Block-Scale.

House-Scale Buildings are the size of a house, typically ranging in footprint from as small as 25 feet up to 75 feet overall, including wings.

Block-Scale Buildings are individually as large as most or all of a block or, when arranged together along a street, appear as long as most or all of a block.



Figure 2.9 House-scale Townhouses consist of a run of 2-4 units, up to 2 stories tall. This building type is appropriate in lower-intensity neighborhoods because it maintains the scale of a large single-unit house.

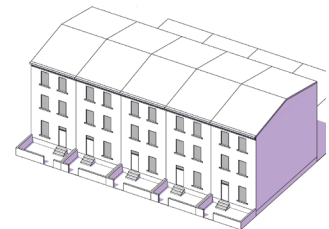

Figure 2.10 Block-scale Townhouses consist of a run of 4-8 units, up to 3 stories tall. This building type is appropriate in moderate to high-intensity neighborhoods since it is larger in scale than a single-unit house.

The Palette of Missing Middle Housing Types



Duplex Side-by-Side
2 units



Duplex Stacked
2 units



Cottage Court¹
3-10 units



Triplex/Fourplex
3-4 units

Typical Characteristics of Missing Middle Housing Types

Vehicular Access	Front	Rear ²	Front	Rear ²	Front	Rear ²	Front	Rear ²
Max. Height (Stories)	1.5 (2.5 if overall building footprint is house-scale)		2.5		1.5 (rear building up to 2.5 stories)		2.5	
Lot Width (ft)	50' - 55'	45'	45' - 50'	45'	110' - 115'	105'	50' - 60'	45'
Lot Depth (ft)	100' - 150'	100'	100' - 130'	100'	205'	160'	110' - 140'	110'
Area of Lot (sf)	5,000 - 8,250	4,500	4,500 - 6,500	4,500	22,550 - 23,575	16,800	5,500 - 8,400	4,950
Resultant Density								
Without ADU	11 - 17.4	19.4	13 - 25	19.4	15 - 19	28.5	20 - 29	35.2
With ADU	15.8 - 26.1	29	20.1 - 26.1	29	n/a	n/a	25.9 - 31.7	44

¹ Variation: Pocket Neighborhood. The lot for this variation is the size of most of a block or up to an entire block, and the shared court is much larger, or there are several shared courts. The individual cottages are expanded to include a mix of Duplex and Fourplex buildings.

² Assumption is 5' side setbacks and 12' setback if front-loaded driveway (street access).

Q CLOSER LOOK

Numerical Figures for MMH Types

The numbers associated with each MMH type are representative of the typical lot width and depth that each type needs to function. However, each type can be further customized to other lot widths and depths. As the lot width and depth increase or decrease, the density numbers will also change.

Missing Middle Housing Palette

The palette of MMH types above identifies the typical lot dimensions for each type. The minimum is what each type needs to provide a high quality living environment for residents, and the maximum is the size beyond which a lot becomes too large to deliver the type of compact development that supports walkable environments. These dimensions need to be adjusted to each community and its particular lot patterns.

The resultant density is the number that results from designing units that fit in each MMH building type. This is different from density regulations that predetermine how many units are allowed without regard for what can actually fit well.

Actual results could vary depending on front or rear vehicular access to parking.



Multiplex Small
5-10 units

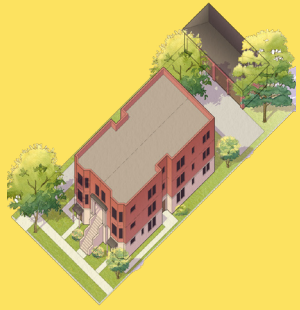

Multiplex Large
7-18 units



Courtyard Building
6-20 units



Townhouse Small
1 unit



Townhouse Large⁴
1 unit

Front	Rear ²	Front	Rear ²	Front	Rear ²	Front	Rear	Front	Rear
2.5 (33)		2.5 (33)		2.5 (33)		2.5		3	
70' - 75'	65'	70' - 105'	65'	100' - 125'	95'	n/a	18' - 25'	n/a	18' - 25'
110' - 150'	110'	115' - 135'	115'	110' - 150'	110'	n/a	100'	n/a	100'
7,700 - 11,250	7,150	8,050 - 14,175	7,475	11,000 - 18,750	10,450	n/a	1,800 - 2,500	n/a	1,890 - 2,625
33.3 - 44.6	60.9	37 - 55.3	69.9	18 - 46.5	88	n/a	16 - 17.5	n/a	18.6 - 55.85
n/a	n/a	n/a	n/a	n/a	n/a	n/a	29 - 35	n/a	37.2 - 74.4

³ In more intense neighborhoods. This type can be designed to have a third story, or a portion of a third story, depending on the intended physical character of the neighborhood. This intensity is referred to as Upper Missing Middle.

⁴ Reflects one unit per Townhouse; however, option to design with one unit per floor, up to 3 units, depending on the context.

⁵ This range reflects one to three units.

Although lot area can be used as a regulating factor, it should not be the primary factor. Instead, lot width and the resulting building width should be the primary regulating factors, as these provide for more targeted regulations that have a greater impact on the quality of the public realm and help to deliver more predictable built results in terms of building form.

These dimensions are the results of years of on-the-ground research and design work for private and public sector clients by Opticos. These dimensions are meant as a starting point, and should be calibrated for the specific on-the-ground

conditions and desired community form wherever MMH types are desired.

The density ranges for each type correspond to the lower number of units with its smaller lot dimensions, and the higher number of units with its larger lot dimensions.

2.3 What Is A Frontage Type?

Definition

Frontage Type. The component of a building that provides an important transition and interface between the public realm (street and sidewalk) and the private realm (building facade).

The ultimate intent of regulating frontages is to ensure, after a building is located appropriately on its lot, that its interface with the public realm and the transition between the two are detailed appropriately.

The names of the frontage types depicted below indicate their particular configuration or function and are based on examples found in cities across the country. Some types may be more or less common in Knoxville. An on-the-ground survey can establish which types are

most representative of the character of buildings in Knoxville.

Why Frontages Are Important for MMH

Missing Middle Housing types are house-scale and generally look like they could be a large single-unit home. Frontage types that are consistent with those used on single-unit homes, such as porches and stoops, help Missing Middle types contribute to the residential look and feel of neighborhoods where they are located. A strong sense of community is an important benefit that MMH types provide to residents and neighbors, and frontage types play a role in supporting this by providing a strong connection to the pedestrian-oriented streetscape.



Figure 2.11 Example of engaged stoop MMH frontage. Multiple units in the building are accessed by a single, shared entry that leads to a hall or small lobby area.

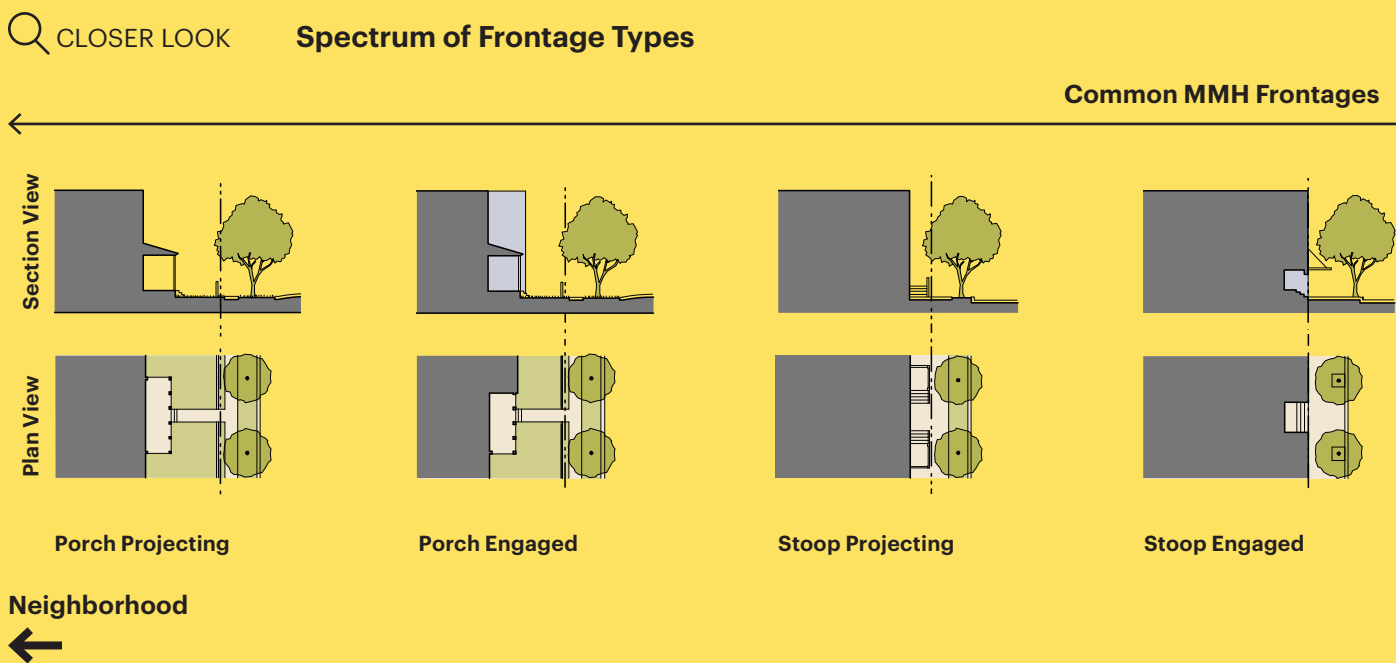

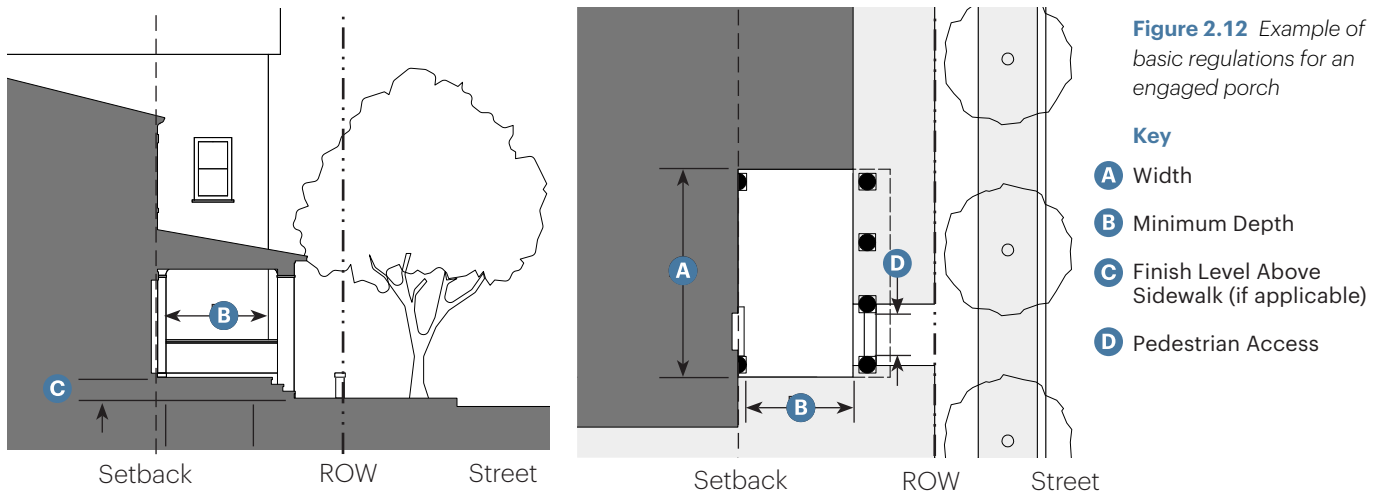

Buildings with entries that are not visible from the street can appear anonymous. Creating clear, distinct entryways with room for socializing reinforces the neighborhood character of Missing Middle types and provides for a more convivial and welcoming streetscape.

Important Features to Regulate¹

Regulations for frontage types should be based on measurements from good local precedents to ensure they are appropriate. For instance, setting the correct minimum depth for stoops and porches is extremely important in order to ensure that they are actually usable, look like they're from the area, and improve the public/private interface by providing residents with a place to sit outside where they can also greet their neighbors.

Source

¹*Form Based Codes: A Guide for Planners, Urban Designers, Municipalities, and Developers*, Dan. Parolek AIA, Karen Parolek, Paul C. Crawford FAICP, Island Press

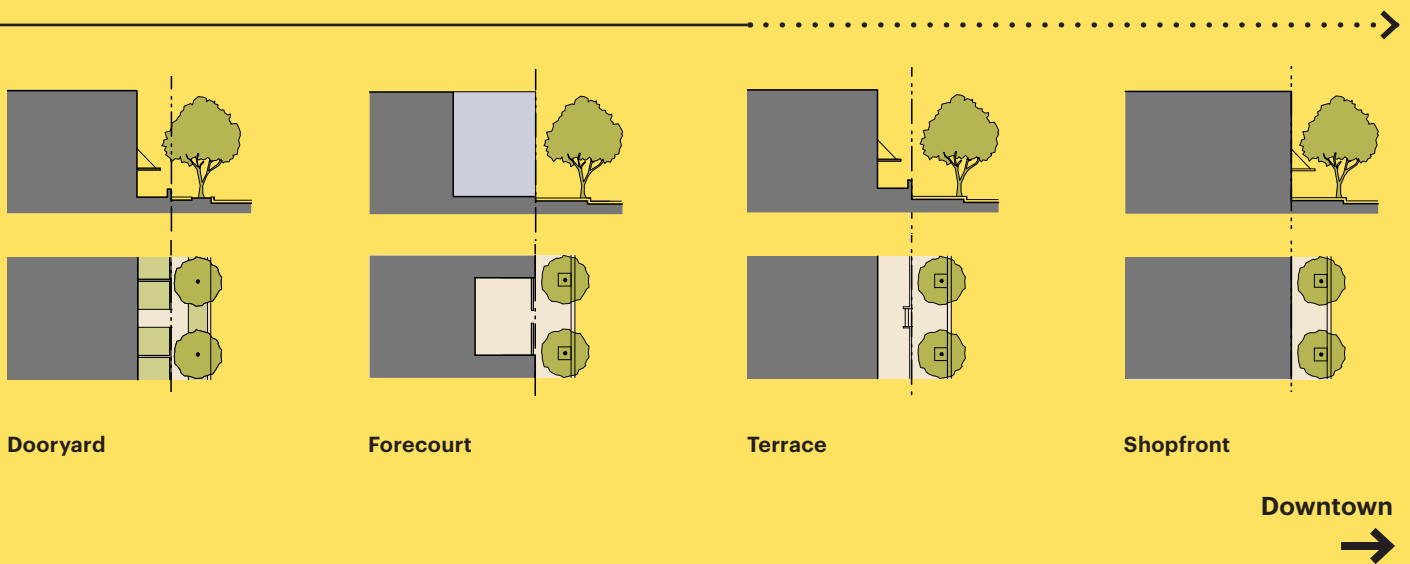

2.4 Missing Middle Housing in Knoxville

Local Examples

Like most urban areas built before the 1940's, Knoxville includes many examples of MMH types (see page 37). These types are found primarily in older neighborhoods. Before the widespread adoption of automobiles, housing needed to be located close to areas where jobs were concentrated, since long commutes were inconvenient or infeasible. In many US urban areas, including Knoxville, MMH was built nearby commercial and industrial areas so that employees could have access to housing nearby their place of work. The images on the facing page (page 37) are examples of MMH types in Knoxville. Other examples of multi-family or medium-density housing exist in Knoxville; however, these examples are not considered MMH per the criteria identified on pages 14-17.

How Were These Built?

Most of the examples were built before the 1940s when previous regulations allowed them. Newer examples of MMH have had to use other zoning tools and processes because current zoning standards often preclude many or all of the MMH types.

Why Did They Go Missing?

Changes to the zoning code, incentives from the federal government to build single-unit homes at the edge of communities, and changes to the real estate finance landscape made it either impossible or financially unattractive to build the types of buildings that today we call "Missing Middle". Recent shifts in consumer demand, a need for both more housing in general and a greater variety of housing type options, and new ways of thinking about zoning provide a common way of expanding housing choice and an opportunity to bring these MMH types back to Knoxville.



Source: Google Maps

Duplex Side-by-Side
2 units



Source: Google Maps

Duplex Side-by-Side
2 units



Source: Google Maps

Triplex
3 units



Source: Google Maps

Townhouse Large
10 units



Source: Google Maps

Multiplex Small
8 units

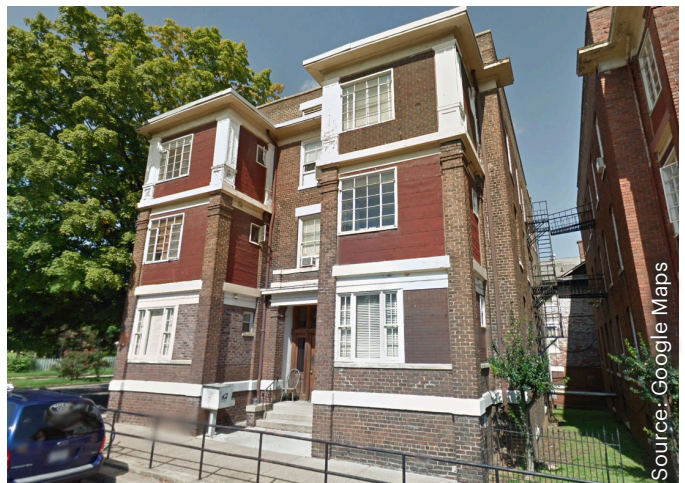

Source: Google Maps

Multiplex Large (Upper MMH)
12 units

2.5 Walkable Centers in Knoxville

Walkable Centers

Missing Middle Housing is part of areas that are anchored by “Walkable Centers” that provide amenities such as schools, recreation, shopping, services, transit, food and employment. Centers can be grouped into three general categories:

- Regional- and community-serving
- Community-serving
- Neighborhood-serving

Each type of center is described and illustrated on the facing page (page 39).



Q CLOSER LOOK

What Is A Walkable Center?

As discussed earlier, MMH is best suited for areas that are anchored by “Walkable Centers” that provide amenities such as shopping, services, transit, food, and employment. A Walkable Center can be either a small group of parcels (Neighborhood Center), or as big as a Downtown, or a Community Center. The point is that for MMH to be successful, MMH needs to be within short walking distance of vibrant centers with some or all of these amenities: food, shops, services, transit, and entertainment.

Walkable Centers are typically well connected to surrounding areas, making them accessible by multiple modes of transportation. Walkable Centers are the

places where communities do things together. In some cases, they are places where people from across the city gather to work, shop, learn, play, and celebrate.

Overall, they serve as walkable, bikeable, or “park-once” destinations where community members can meet multiple daily needs in a single trip. When thriving, they are nodes of activity that enliven a neighborhood.

A 1/4 and 1/2 mile radius drawn around the Walkable Center shows a 5 and 10 minute walking (5-minute biking) distance from the Walkable Center. These areas are considered especially good locations for MMH.



Regional-Serving

A citywide destination for retail, food uses, service, employment, entertainment and recreation that includes significant housing.



Community-Serving

A community destination for retail, food uses, and services that is an amenity for adjacent neighborhoods. Examples of Community-Serving-Serving Centers are listed below:

- E Magnolia Ave + Cherry St
- N Central St + E Springdale Ave
- Heiskell Ave + Johnston St



Neighborhood-Serving

A neighborhood destination of food, shops, and services at the intersection of two important streets that provides convenient services to the immediately adjacent residential neighborhoods. A Neighborhood-Serving Center is smaller and less intense than a Community Center.

Examples of Neighborhood Centers are listed below:

- Sevierville Pike + Sevier Ave
- Whittle Springs Rd + Washington Pike
- Minnis Ave + S Haven Rd
- Martin Luther King Jr Ave + S Chestnut St

Where Are Knoxville's Walkable Environments?

The map shows existing walkable environments in Knoxville focused around a variety of “Walkable Centers” and corridors identified through this analysis.

Figure 2.13 Walkable environments (Centers and Corridors) in Knoxville.

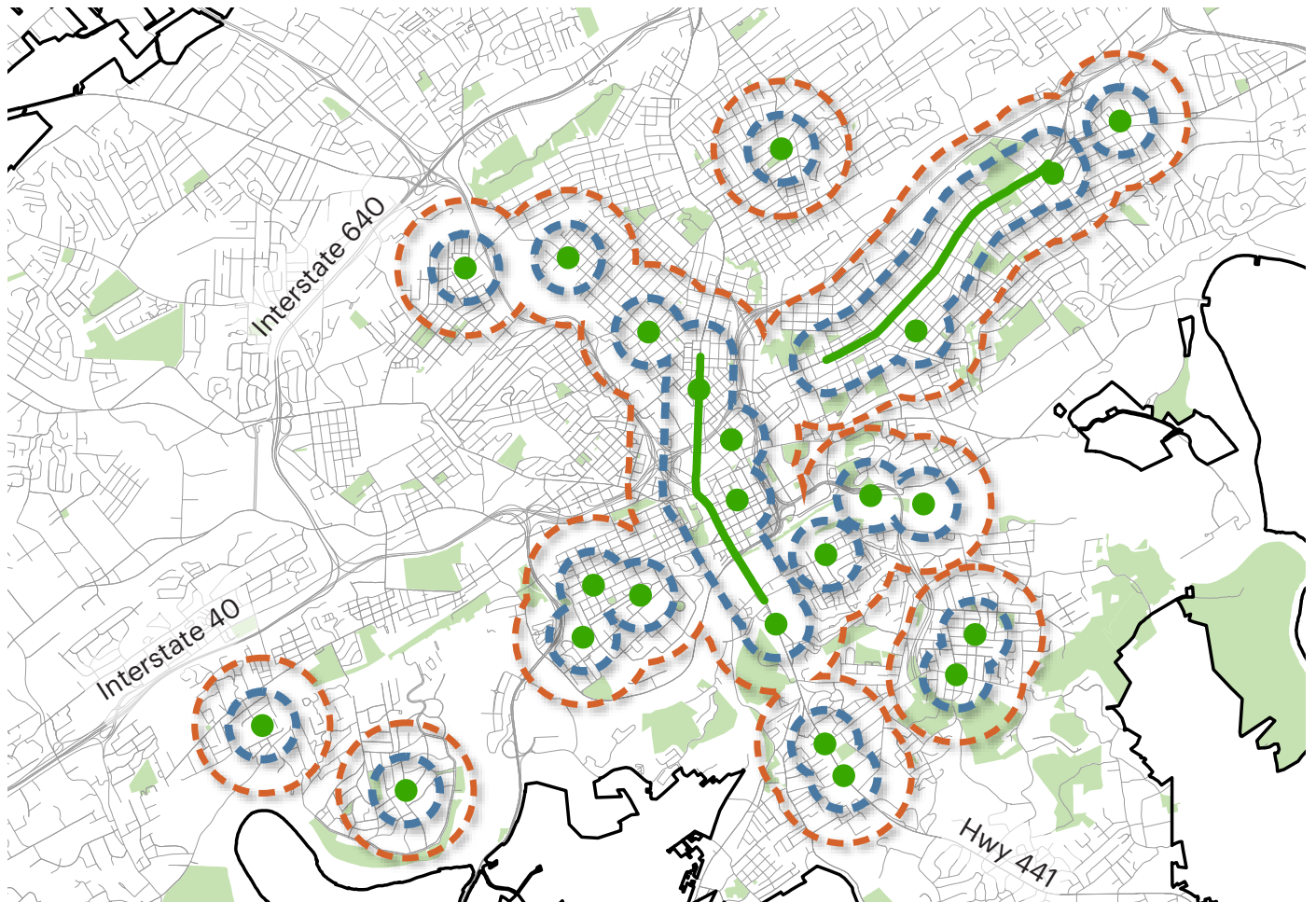

Identified Walkable Environments

- Center
- Corridor
- - - 5 min. Walking Distance
- - - 10 min. Walking Distance, 5 min. Biking Distance

Other Amenities

- Park/ Open Space

Current Zoning within Walkable Environments

The map shows the location of the four zoning districts analyzed in relation to existing Walkable environments. Please see page 45 for information on potential Walkable Centers and their location relative to the four zones analyzed.

Figure 2.14 Location of four zoning districts analyzed and existing Walkable environments

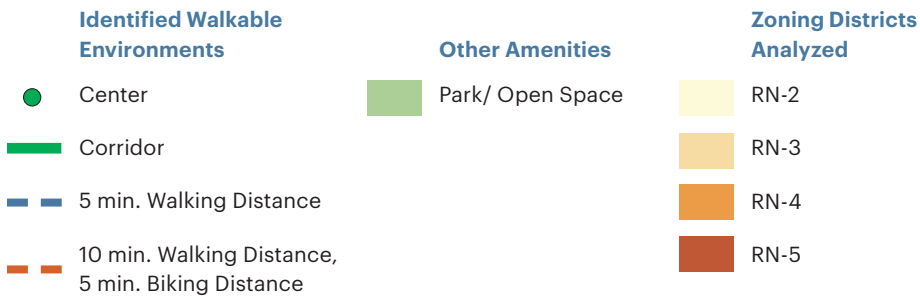
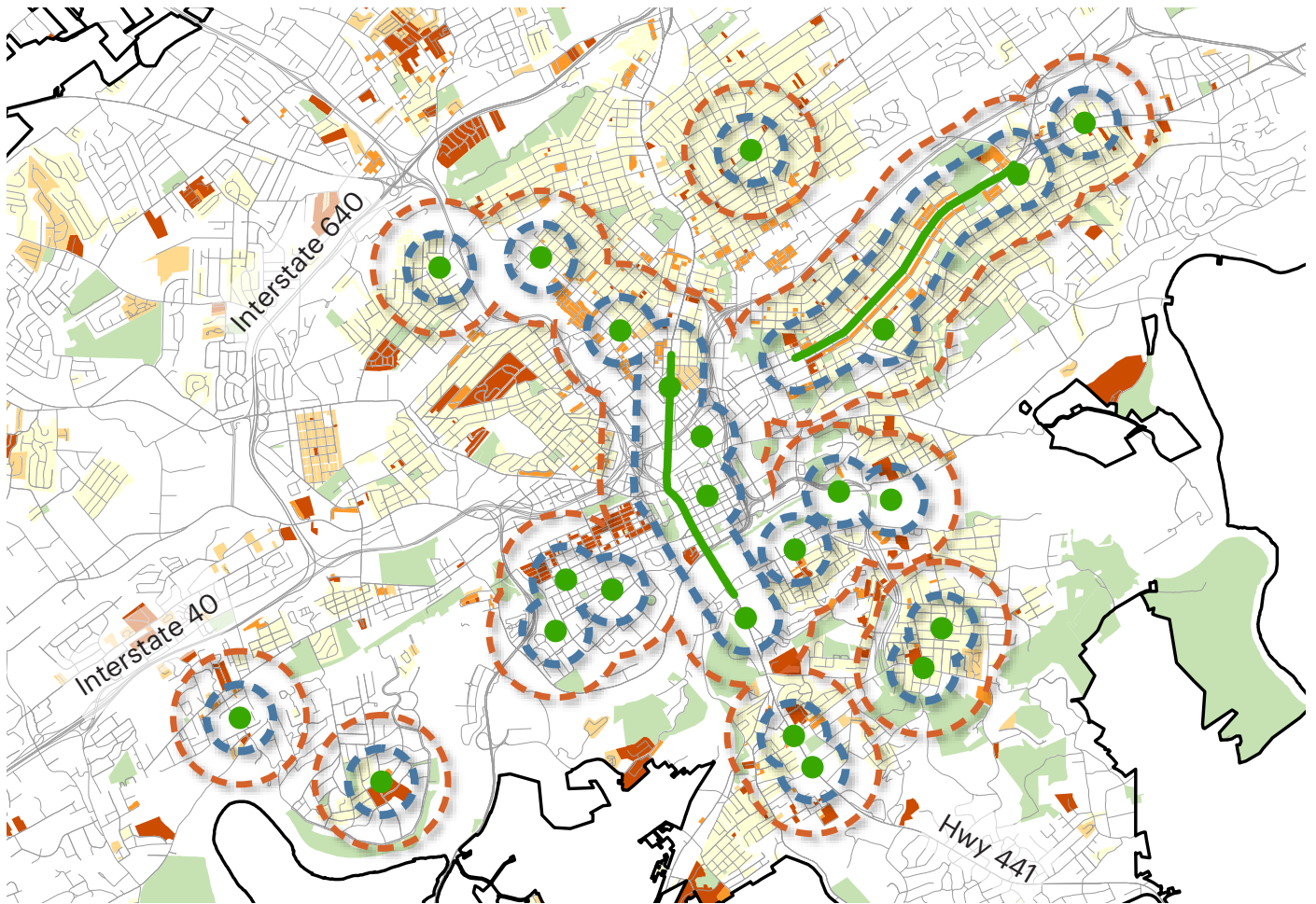

2.6

Missing Middle Housing-Ready Neighborhoods

Beyond the Traditional Neighborhood Pattern

Missing Middle Housing types are most successful when located in an existing or newly built walkable context. Buyers and renters of these housing types are looking for walkability and are willing to make trade-offs on other housing features, such as unit size. For most urban areas, including Knoxville, the most walkable neighborhoods are those located near Downtown around the historic core.

Missing Middle Housing types can be built in an auto-oriented context, but they will not attract the same kind of buyer or renter, will not deliver more compact, sustainable patterns of development, and will not achieve the same returns or rents for developers. The higher the walkability of a project context, the smaller the units can be, and the less off-street

parking is needed, which can improve the attractiveness of Missing Middle types for developers.

Like most mature urban areas, Knoxville's walkable urban core and traditional neighborhood areas are surrounded by newer neighborhoods characterized by a pattern of development that is more oriented towards automobile use. In many instances, these neighborhoods share many of the same walkable characteristics as the core and traditional neighborhoods to which they are adjacent, but certain walkable elements may be missing or may suffer from under-investment. It is these neighborhoods, where incremental changes can improve walkability, that are "Missing Middle Housing-Ready (MMH-Ready)".

Q CLOSER LOOK

What Does "Walkable" Mean?

For the purpose of this study, walkable describes places where a person can walk or bike to fulfill some or all daily needs. These environments accommodate the use of automobiles but do not require one for every trip.

Walkable does not mean recreational walking such as on paths and trails, but rather walking to a destination like work, services, a coffee shop, restaurants, bars, entertainment, schools, civic uses, parks, and other amenities.

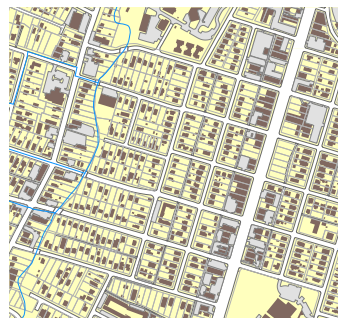

Ideal for MMH

Walkable

Small block lengths, a well-connected street network, and nearby services, shops, and restaurants on a local Main Street support a high degree of walkability for this historic neighborhood.

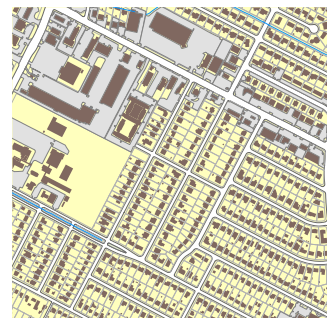

Appropriate for MMH

"MMH-Ready"

A well-connected street network with a mix of block lengths provides a walkable foundation that will support MMH types and enable pedestrian-scale redevelopment of adjacent commercial parcels.

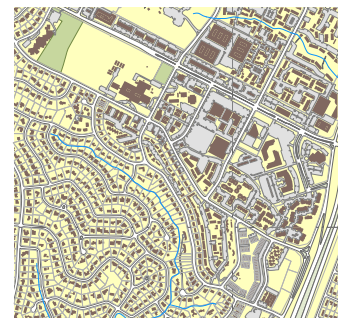

Not Appropriate for MMH

Automobile-Oriented

Minimally-connected streets with frequent cul-de-sacs and commercial areas accessible primarily via higher-speed roadways do not provide a successful environment for MMH.

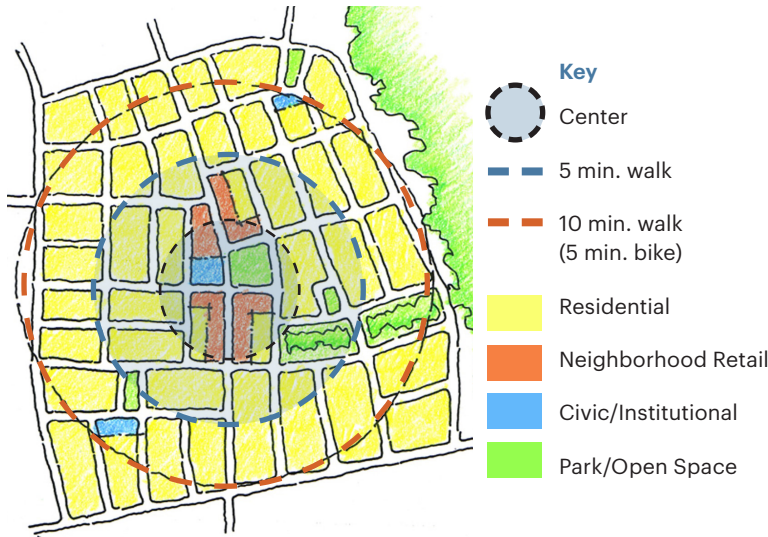

Figure 2.15 Proximity to neighborhood retail, open space, and civic buildings helps to support walkable, MMH-Ready neighborhoods

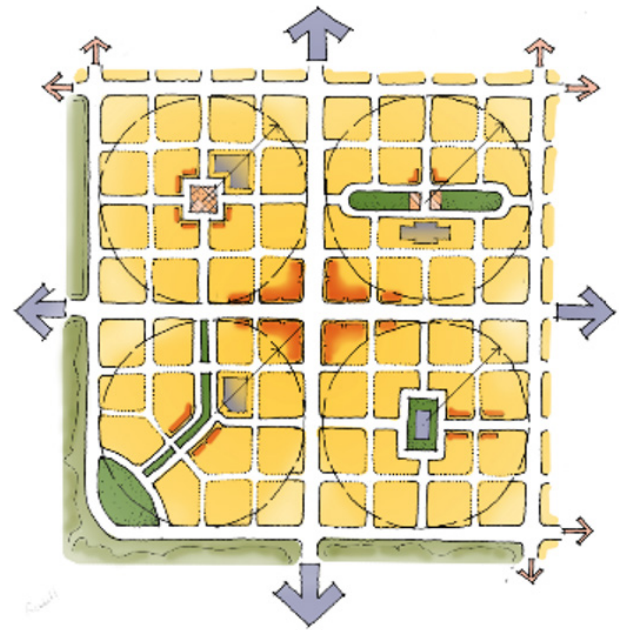

Figure 2.16 How multiple walkable neighborhoods form a walkable environment around the intersection of two major roadways

What Are the Characteristics of a MMH-Ready Neighborhood?

- **Smaller block sizes** that allow for better street network connectivity. Smaller block patterns encourage walkability by providing more route choices and reducing the walking distance to get between destinations. In general, dead-end streets, cul-de-sacs, and looping streets diminish an area’s walkability, while through-streets tend to increase walkability.
- **Access to bicycle routes** to provide an alternative to driving for longer-distance destinations. Safe, convenient, and well-connected bicycle facilities provide transportation options for destinations that are too far away for walking.
- **Accessible to mixed-use areas** that make it possible to satisfy most daily needs — living, working, playing, shopping, dining, worshiping, and socializing — without needing to leave the neighborhood. While commuting for work, school, and special trips may still require transit or a car, most of the daily needs should be accessible within a ten-minute walk or one-half mile from housing.

- **Appropriate zoning** that allows for a variety of housing types and encourages compact development to support walkability.
- **Small to medium lot sizes** that promote house-scale development and disincentivize large tracts of identical housing types, where repetition of building forms leads to a diminished public realm.

Support for MMH-Ready Neighborhoods

To support MMH outside of traditional neighborhoods adjacent to and around Downtown where walkability is high, Knoxville should consider making investments in MMH-Ready neighborhoods to make it more convenient for people to walk and bike from their homes to everyday destinations such as school, work, shopping, and recreation, if they choose to do so. A combination of infrastructure improvements and new or improved amenities can help to signal that MMH-Ready neighborhoods are available for new housing choices.

Where Are Knoxville's Potential Missing Middle Housing-Ready Environments?

The map identifies the potential Walkable Centers and Corridors in MMH-Ready environments identified through this analysis.

Figure 2.17 Potential Walkable Centers and Corridors in MMH-Ready environments

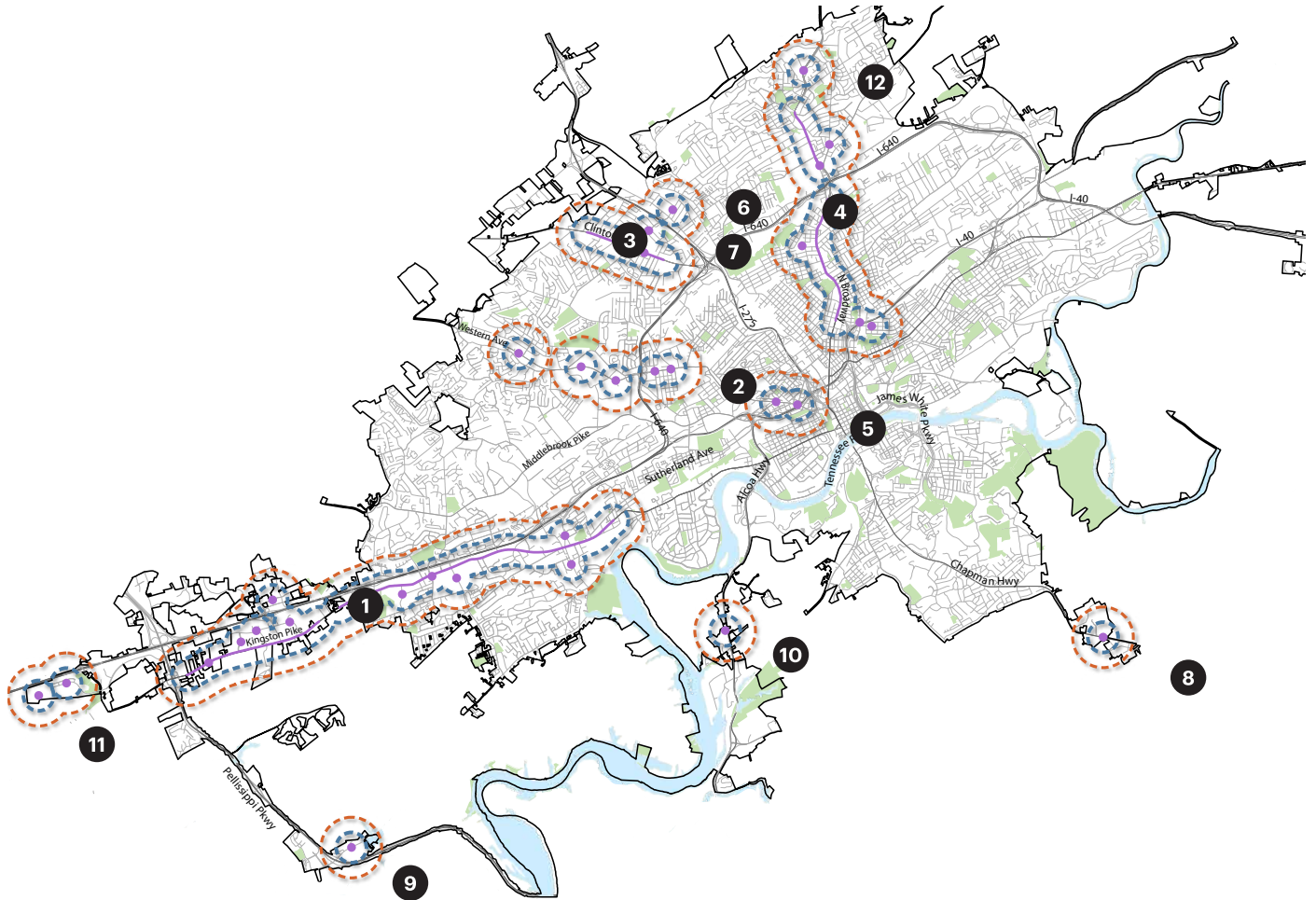

Potential MMH-Ready Environments

- Center (Auto-oriented/Transformable)
- Corridor (Auto-oriented/Transformable)
- 5 min. Walking Distance
- 10 min. Walking Distance, 5 min. Biking Distance

Auto-oriented/Transformable: Potentially MMH-Ready Environments

Corridors		Centers	
1	Interstate 40	5	Intersection of Western Ave + Middlebrook Pike
2	Hwy 62 (Western Ave)	6	Intersection of Interstate 75 + Merchant Dr
3	Hwy 25W (Clinton Hwy)	7	Intersection of Clinton Hwy + Merchant Dr
4	Hwy 441 (N Broadway)	8	Intersection of Hwy 441 + Hwy 168
9		9	Intersection of Northshore Dr + Pellissippi Pkwy
10		10	Intersection of Hwy 129 + Ginn Dr
11		11	Intersection of Hwy 162 + Interstate 40
12		12	Intersection of N Broadway + Jacksboro Pike

Current Zoning within Potential Missing Middle Housing-Ready Environments

The map shows the location of the four zoning districts analyzed in relation to the potential Walkable Centers and Corridors in MMH-Ready environments identified through this analysis.

Figure 2.18 Location of four zoning districts analyzed and MMH-Ready environments

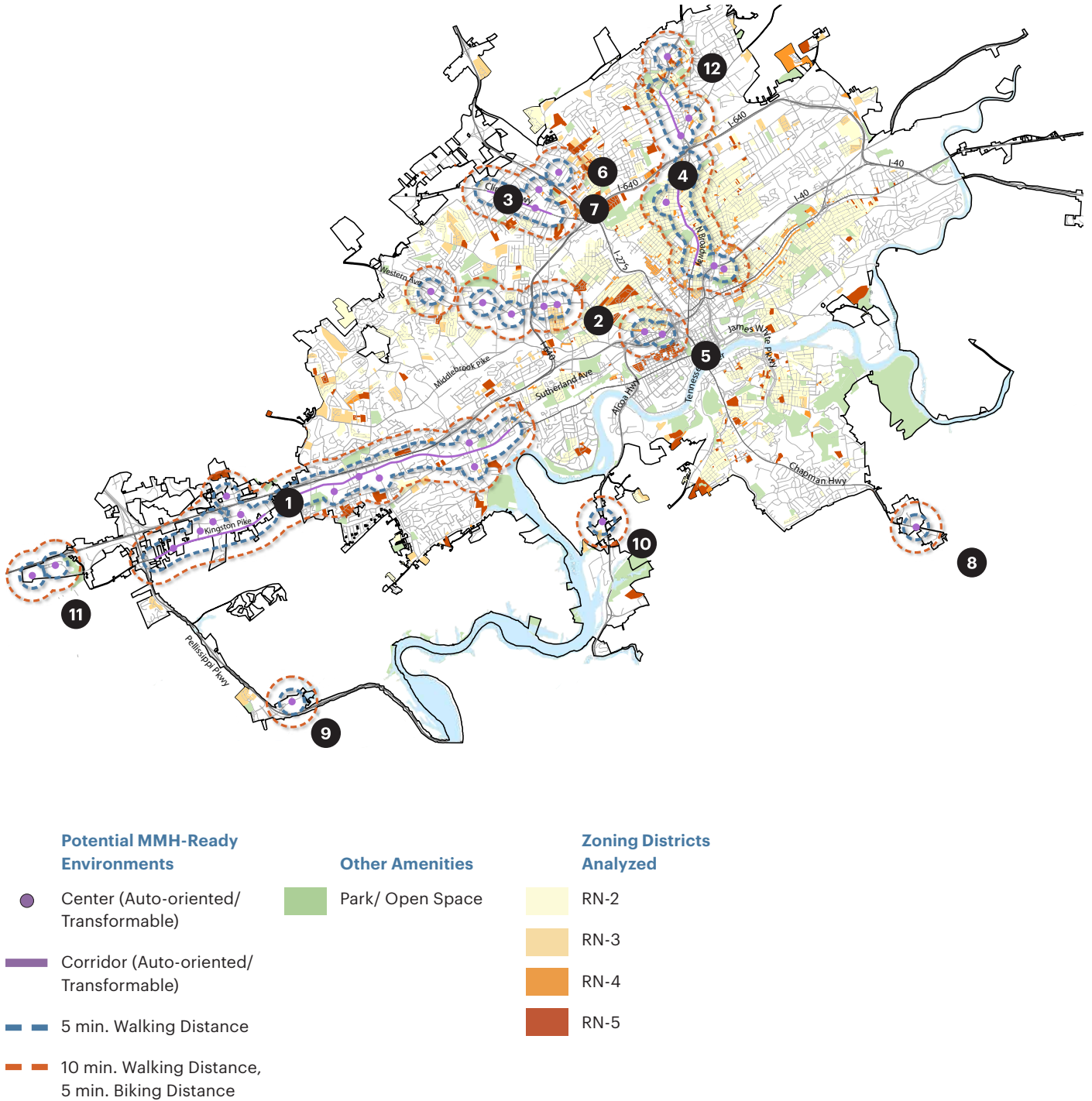

Creating A New Walkable Center for MMH-Ready Neighborhoods

An important component of walkable neighborhoods is a destination to which to walk. Potential Walkable Centers provide that destination by creating space for neighborhood-serving retail, services, institutional and public uses in a pedestrian-oriented environment. These places already exist near Knoxville's traditional neighborhoods but either lack the walkable services, food uses, and shops, or these amenities are currently in auto-oriented environments. However in areas outside of the city core, the approach to create such places could involve transforming existing commercial

centers, like an old mall or shopping center, or by developing a Walkable Center on undeveloped land.

New or redeveloped Walkable Centers have the potential to transition an area from an auto-oriented pattern of development to a more walkable environment that can transform nearby areas into MMH-Ready neighborhoods.

Figure 2.19 on the facing page (page 47) illustrates an example of transforming an existing commercial center (Clinton Plaza).

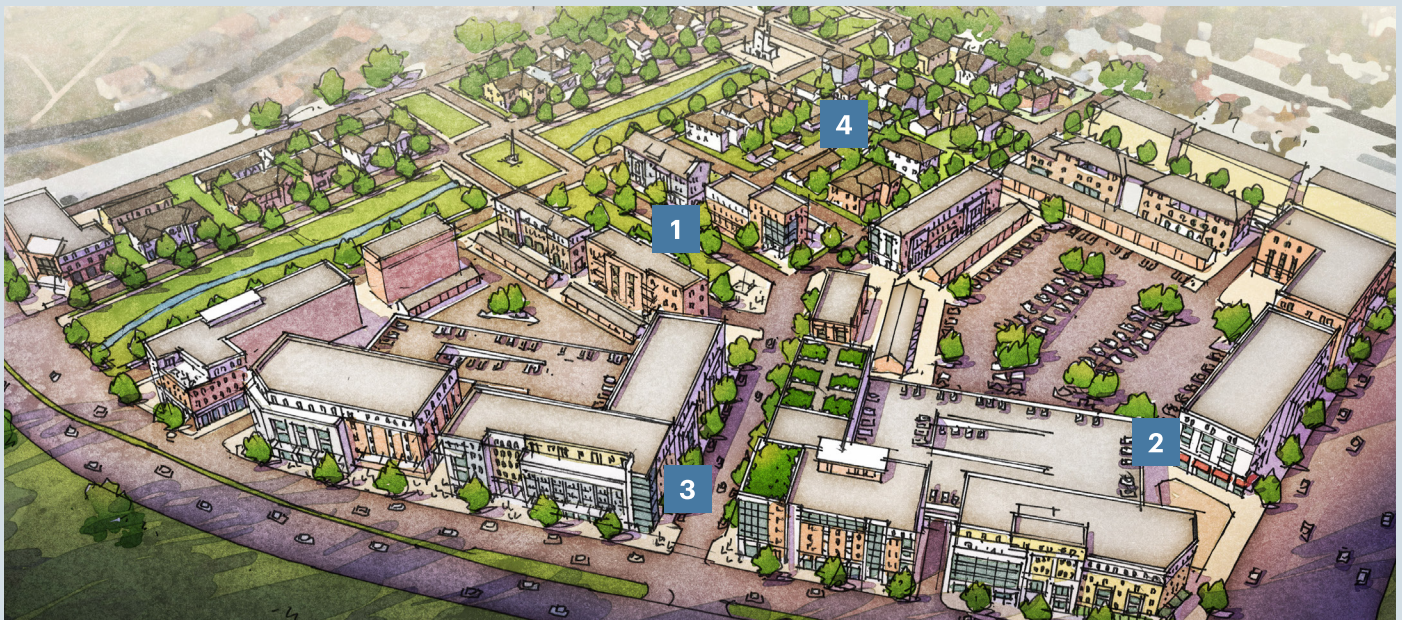

Key Elements of A Walkable Center

An example from Austin, TX shows the transformation of a declining shopping center. While the scale of development in Knoxville would likely be different, the following characteristics still apply:

- **Mixed-use** to satisfy the conditions of a vibrant active node that offers a variety of choices, from dining, entertainment, housing and amenities

- **Pedestrian-oriented** and active public spaces to create a more welcoming and safe environment for residents, employees, customers, and visitors.
- **Multi-modal access** that allows people living nearby to access the Walkable Center by biking, walking, or driving.
- **Transition areas** to ensure compatibility with adjacent residential neighborhoods.



Figure 2.19 Redevelopment of the Clinton Plaza could result in a new Walkable Center by reconfiguring the commercial uses into a community-level Main Street with a variety of housing that includes MMH as a transition to existing neighborhoods.



1
Mixed-use Center
as the Destination



2
Pedestrian-oriented
Physical Character



3
Multi-modal Access



4
House-scale
Transitions to Adjacent
Neighborhoods

One-Size Doesn't Fit All

A Walkable Center is not limited to a certain size. Smaller centers, like a Neighborhood Center, or a small Community Center can do a lot to support nearby MMH-Ready neighborhoods. These small mixed-use areas can be easily embedded into or adjacent to residential neighborhoods because they are residential in scale and provide convenient services for nearby residents who can meet multiple daily needs in a single trip made by foot, bike, or car. These neighborhood-scale Walkable Centers

can serve as nodes of local activity that help to enliven a neighborhood and build community.

Smaller block sizes allow for better street network connectivity and encourage walkability by providing more route choices and reducing the walking distance to get between destinations. In general, dead-end streets, cul-de-sacs, and looping streets diminish an area's walkability, while through-streets tend to increase walkability.

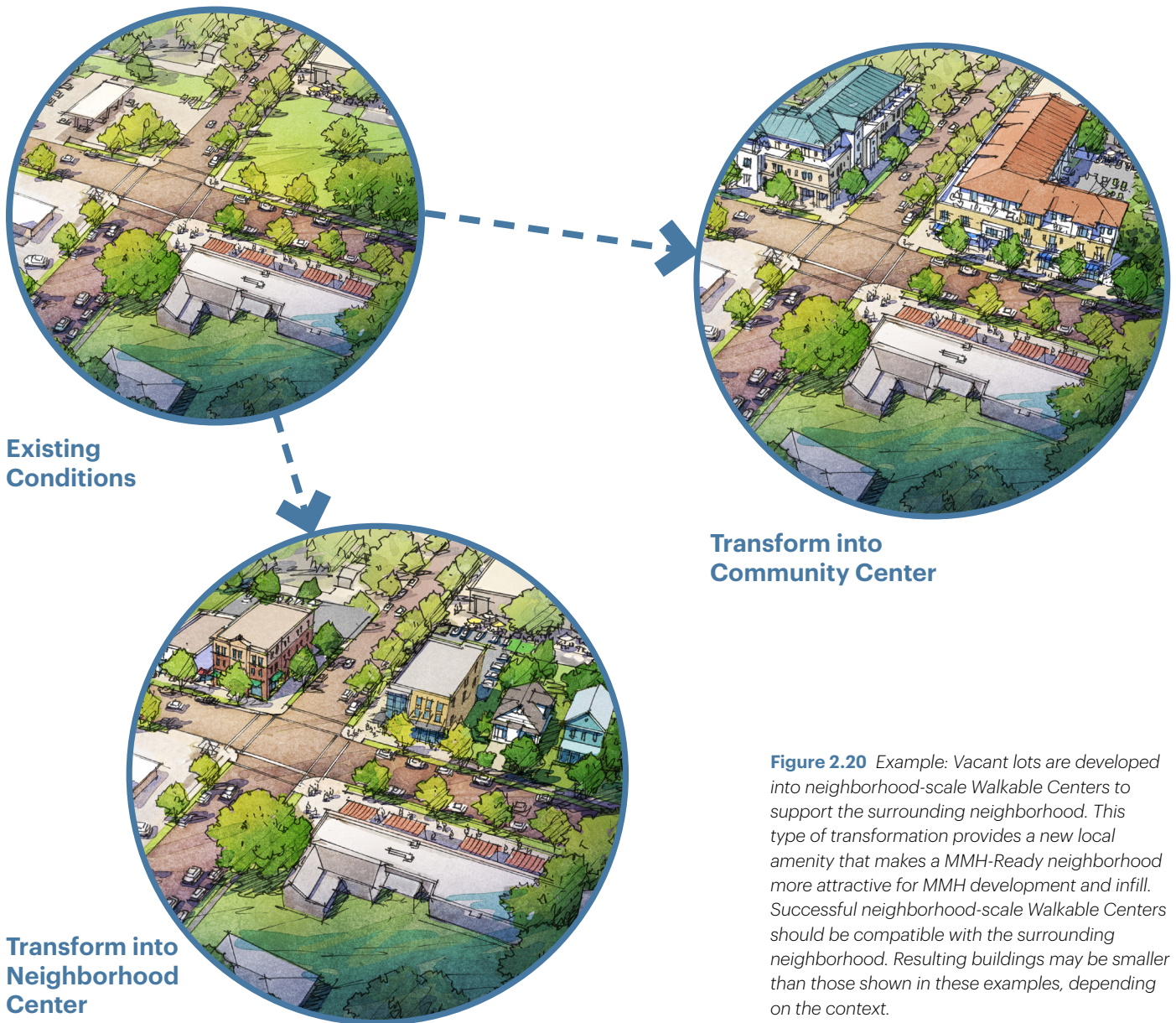
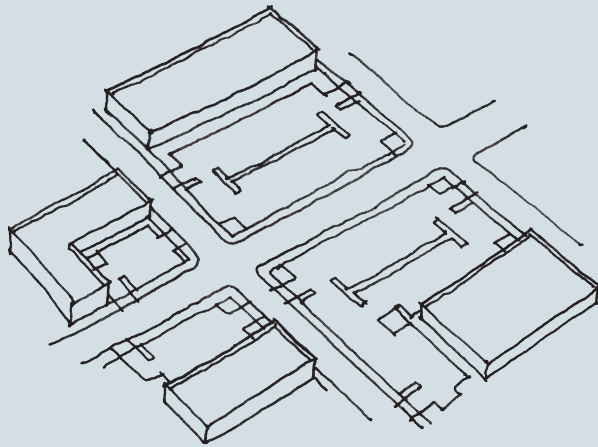

Figure 2.20 Example: Vacant lots are developed into neighborhood-scale Walkable Centers to support the surrounding neighborhood. This type of transformation provides a new local amenity that makes a MMH-Ready neighborhood more attractive for MMH development and infill. Successful neighborhood-scale Walkable Centers should be compatible with the surrounding neighborhood. Resulting buildings may be smaller than those shown in these examples, depending on the context.

Incremental Change

Small, incremental changes can be just as important in the long run as big, transformative change. The following incremental changes can lay the groundwork for a Walkable Center that can transform surrounding neighborhoods into MMH-Ready Neighborhoods and create suitable environments for MMH.



Existing Conditions

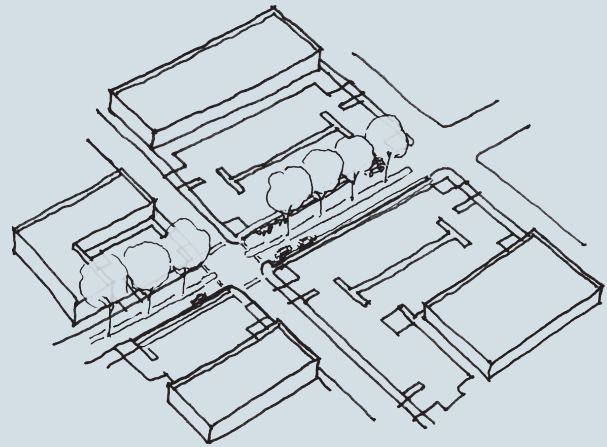

Step 1

Small changes could include landscaping, streetscape improvements and shared roads for bikes and cars.

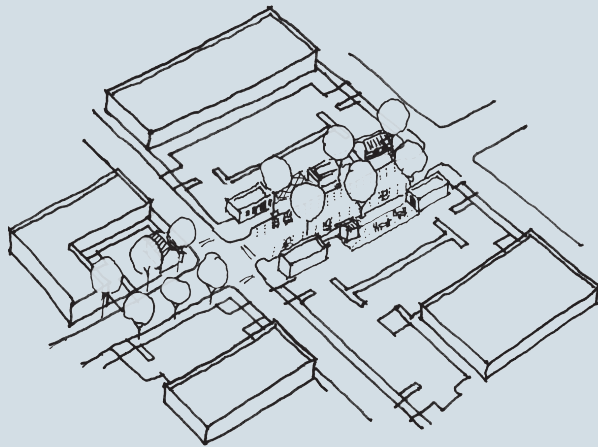

Step 2

Temporary spaces for businesses at sidewalk edge can help form a center of activity. These small changes can be made where buildings and lots are privately owned and where major changes in near term are unlikely.

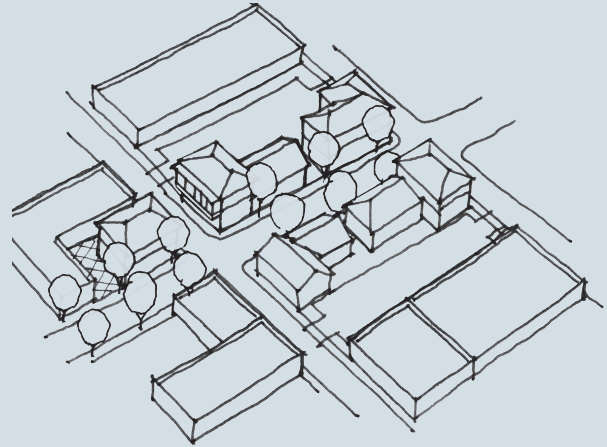

Step 3

Bigger changes may include infill, new development at the sidewalk edge or around public space in areas where there is a desire for urban character and new buildings.



Figure 3.1

Map of Existing Walkable and Potential Walkable Centers and Existing Zoning

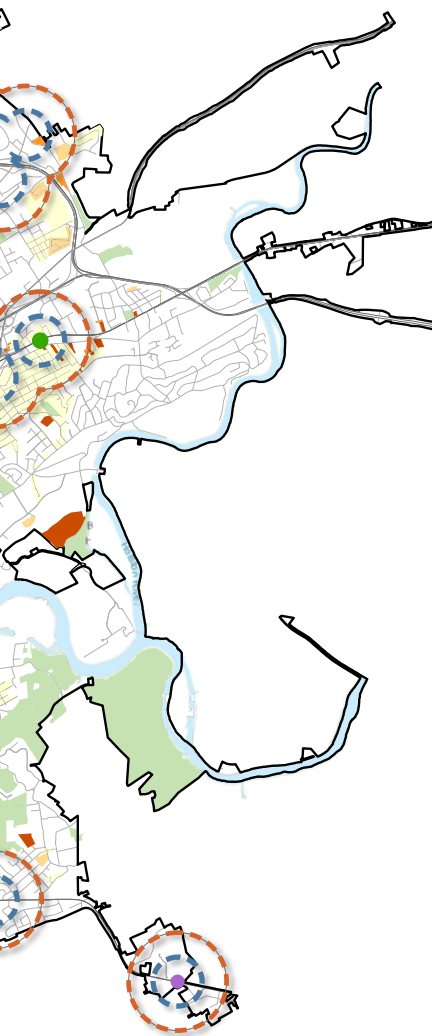

Analysis of Barriers

CHAPTER

3

In this chapter

Comprehensive Plan	52
Zoning Districts and Standards	56
Summary of Barriers	66
Allowed Density	68
Minimum Lot Width	70
Next Steps	72

3.1 Comprehensive Plan

The following analysis identifies which MMH Types are encouraged or enabled by current policy and provides recommendations for addressing existing barriers to MMH.

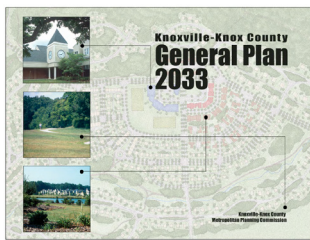

Figure 3.2

Knoxville General Plan

The following analysis identifies which MMH Types are encouraged or enabled by current policy and provides recommendations for addressing existing barriers to MMH.

The 2033 Knoxville-Knox County General Plan is divided into 12 sectors, each of which has a plan that is incorporated into the General Plan. These Sector Plans provide specific policy direction, with some providing more discussion on infill housing and walkable environments than others. The City additionally has Small Area Plans and Corridor Plans that serve similar functions. The plans with direction that is potentially relevant to MMH are discussed below.

Bearden Village Plan

■ **Opportunities.** Some areas in the plan area are of MMH scale. Opportunities are along corridors between nodes and along side streets, specifically at Old Kingston Pike SW & S Forest Park Blvd.

■ **Barriers/Concerns.** The plan is not clear on the intended physical scale of new development. The plan includes direction to downzone many multifamily zoned parcels to low density single family. It's not clear if this has occurred or if it is still a priority.

- **Recommendation 1:** Provide clarity on the intended physical scale of new development. Where properties have not been downzoned to low density

single family, clarify where MMH is intended. It is important to maintain particular attention on MMH types because of the possibility of this scale of housing being grouped with conventional multifamily development.

Broadway-Central-Emory Small Area Plan

■ **Opportunities.** Some areas in the plan area are of MMH scale. Opportunities are along Broadway and Central Corridors (C-Zoned areas) or in adjacent low density single family neighborhoods as a transition to the corridors. Upper MMH is possible on these corridors.

■ **Barriers/Concerns.** The plan identifies several changes in zoning. It's not clear if this has occurred or if it's still a priority.

- **Recommendation 2:** Resolve if the changes in zoning have occurred and if not, if they are to occur. Depending on the intended physical scale of new development, clarify where MMH is intended.

Lonsdale Redevelopment Plan

- **Opportunities.** Some areas in the plan area are of MMH scale but it's not clear if there are opportunities because of the vague content and lack of direction in the plan.
- **Barriers/Concerns.** Although MMH could work well here, it's not clear if MMH is within the intended scale because the plan does not identify the intended scale of new development.
- **Recommendation 3:** Provide clarity on the intended physical scale of new development; Depending on the intended physical scale of new development, clarify where MMH is intended.

Magnolia Avenue Corridor Plan

- **Opportunities.** Many areas in the plan area are of MMH scale and MMH could work very well here especially in Form-Zone MA 2. Upper MMH could work well here in Form-Zone MA 3.
- **Barriers/Concerns.** Although MMH and Upper MMH could work well here, it's not clear if the Form-Zones have been applied to this plan area. Further, there is some reference to downzone certain parcels to low density single family. It's not clear if that has occurred or if it's still a priority.
- **Recommendation 4:** Confirm if the direction to downzone to low density single family has occurred and if not, is it to occur. If not to occur, depending on the intended physical scale of new development, clarify where MMH and Upper MMH are intended.

Martin Luther King Corridor Plan

- **Opportunities.** Some areas in the plan area are of MMH scale. MMH could work very well here especially in the blocks behind the 5-points main street(s) as well as around Union Square.
- **Barriers/Concerns.** It's not clear if the Infill Housing Overlay has been applied to the plan area. Further, there is some reference to downzone certain parcels to low density single family. It's not clear if that has occurred or if it's still a priority.
- **Recommendation 5:** Confirm if the Infill Housing Overlay has been applied and if not, if it's still to be applied and identify those locations. If to be applied, remove the ten-acre requirement. Confirm if the direction to downzone to low density single family has occurred and if not, if it's still to occur. If not to occur, depending on the intended physical scale of new development, clarify where MMH and Upper MMH are intended.

East City Sector Plan

- **Opportunities.** Many areas in the plan area are of MMH scale. MMH could work very well here especially along corridors between nodes and adjacent to low density single family neighborhoods as a transition in scale.
- **Barriers/Concerns.** Although MMH could work very well here, the plan directs the downzoning of parcels to low density single family. It's not clear if that has occurred or if it's still a priority.
- **Recommendation 6:** Confirm if the direction to downzone to low density single family has occurred and if not, is it to occur. If not to occur, depending on the intended physical scale of new development, clarify where MMH and is intended.

North City Sector Plan

■ **Opportunities.** Many areas in this plan area are of MMH scale. MMH could work very well here especially in the MU-NC5 and MU-NC7 zones as well as in the Infill Housing District.

■ **Barriers/Concerns.** Although MMH could work very well here, it's not clear if the Infill Housing District has been applied to the plan area. In addition, the ten-acre minimum parcel size required for the Infill Housing District is a barrier because MMH can fit on parcels that are the same size as single-family parcels. Last, the plan discusses the downzoning of parcels to low density single family. It's not clear if that has occurred or if it's still a priority.

- **Recommendation 7:** Confirm if the Infill Housing Overlay has been applied and if not, if it's still to be applied and identify those locations. If to be applied, remove the ten-acre requirement. Confirm if the direction to downzone to low density single family has occurred and if not, if it's still to occur. If not to occur, depending on the intended physical scale of new development, clarify where MMH and Upper MMH are intended.

Northwest City Sector Plan

■ **Opportunities.** Some areas in this plan area are of MMH scale. MMH could work well here in the MDR and MU designations as well as at the edges of Neighborhood Centers and along corridors between nodes.

■ **Barriers/Concerns.** Although MMH could work well here, it appears that the MDR and MU designations do not allow MMH because the maximum allowed densities (24/acre and 12/acre respectively) are at the low end of the MMH spectrum. It's also not clear if the intended scale of new development is to include development of house-scale buildings such as MMH.

- **Recommendation 8:** Provide clarity on the intended physical scale of new development; Depending on the intended physical scale of new development, clarify where MMH is intended; For MMH development, either remove the maximum density requirements and regulate number of units and building size, or increase the maximum density requirements to fit the selected MMH types.

South City Sector Plan

■ **Opportunities.** Some areas in this plan area are of MMH scale. MMH could work well here especially along or behind the Chapman Highway District (SC-5).

■ **Barriers/Concerns.** Although MMH could work very well here, the MDR's maximum density (24/acre) is too low for several MMH types. In addition, the maximum density of 2 units per acre on parcels with 15 to 25 percent slope is also very limiting to MMH because several house-scale MMH types could work on slopes of 15 percent while generating densities of 18 to 30 units per acre (Duplexes, Triplexes, Fourplexes). Last, the MU-NC zone is also a limitation to MMH as it only allows 12 units per acre.

- **Recommendation 9:** Provide clarity on the intended physical scale of new development; Depending on the intended physical scale of new development, clarify where MMH is intended; For MMH development, either remove the maximum density requirements and regulate number of units and building size, or increase the maximum density requirements to fit the selected MMH types; Allow MMH on slopes up to 15 percent while increasing the maximum density to fit the selected MMH types.

Vestal Neighborhood Plan

- **Opportunities.** Some areas in this plan area are of MMH scale. MMH could work well here along the edges of this center.
- **Barriers/Concerns.** Although MMH could work very well here and the plan’s narrative could be interpreted to support MMH, it doesn’t explicitly identify MMH as an expectation which could be problematic to implementation. Last, it’s not clear what zoning is to be applied to this area.
- **Recommendation 10:** Provide clarity on the intended physical scale of new development; Depending on the intended physical scale of new development, clarify where MMH is intended.

West City Sector Plan

- **Opportunities.** Some areas in this plan area are of MMH scale. MMH might be possible but the plan is not clear enough to provide a conclusion here.
- **Barriers/Concerns.** Although MMH could work well here, the MDR’s maximum density (24/acre) is too low for several MMH types. Further, despite the 24/acre density being too low for MMH, the corridors appear to be intended for development of higher intensity than MMH or even Upper MMH.
- **Recommendation 11:** Provide clarity on the intended physical scale of new development; Depending on the intended physical scale of new development, clarify where MMH or Upper MMH are intended.

3.2 Zoning Districts and Standards

The following analysis identifies which MMH Types are enabled by current Knoxville Zoning Code



Figure 3.3

The palette of MMH types ranges from buildings with 2 units to Courtyard Buildings with up to 20 units representing a resultant density range of about 10 to 50 or 60 du/acre, depending on lot sizes.

Terminology

This analysis assumes that “two-family dwelling” includes MMH types Duplex Side-by-Side and Duplex Stacked, “townhome” includes MMH types Townhouse Small and Townhouse Large, and “multi-family” includes the remaining MMH types - Cottage Courts, Triplex/Fourplex, Small and Large Multiplexes, and Courtyard Buildings.

Zoning Districts (Zones)

The following analysis focuses on the four zones (RN-2, RN-3, RN-4, and RN-5) selected by the City for this study. The analysis identifies which MMH types are possible in each zone regarding density, lot area, lot width, parking minimums, building setbacks, lot coverage, building height, and entitlement requirements. Other requirements including prioritizing MMH, applying the findings in this MMH Scan™, and making changes to zoning to enable MMH are analyzed in Section 3.6 (page 66).

■ **RN-2:** This zone does not support MMH due to the combined barriers of density, lot area, parking, and allowed use-requirements.

Density. The maximum density of 6 du/acre is below the minimum needed (11/acre) for the least intense MMH type (Side-by-Side Duplex).

Lot area. The minimum requirement of 10,000 square feet for two-family homes is twice as much than necessary for both Duplex types and the Triplex/Fourplex.

Off-street Parking. The minimum requirement for two-family homes (2 spaces per unit) is a barrier especially to existing infill lots less than 100 feet wide.

Allowed Uses. MMH types beyond the Duplex types are not allowed uses.

- **Recommendation 12:** For MMH developments, do not regulate density. If necessary to regulate density, coordinate maximum allowed densities to what’s needed for the selected range of MMH types in the zone; For MMH developments, do not regulate minimum lot area. Instead, regulate minimum lot width according to the needs of the selected MMH types; For MMH developments within 1,000 feet of a walkable center, cap the required parking at 1 space per unit.
- **Recommendation 13:** Remove specific building types from the use-table in the zone and instead, identify in the development standards which building types are allowed.

■ **RN-3:** This zone supports some MMH types but contains the following barriers: maximum density, minimum lot area and minimum parking requirements.

Density. The maximum allowed in much of this zone is 24 per acre which allows the Duplex Side-by-Side / Duplex Stacked by right and the Townhouse Small / Townhouse Large with Planning Commission approval.

Lot area. The minimum required areas for two-family homes and for townhomes is greater than necessary to fit these MMH types on typical lots.

Off-street Parking. The minimum requirement for two-family homes (2 spaces per unit), for townhomes (2.25 spaces per unit), and for multi-family (starts at 1.5 spaces per unit) is a barrier especially to existing infill lots less than 100 feet wide.

- **Recommendation 14:** For MMH developments, do not regulate density. If necessary to regulate density, coordinate maximum allowed densities to what's needed for the selected range of MMH types in the zone; For MMH developments, do not regulate minimum lot area. Instead, regulate minimum lot width according to the needs of the different MMH types; For MMH developments within 1,000 feet of a walkable center, cap the required parking at 1 space per unit.

■ **RN-4:** This zone generally supports MMH, but contains the following barriers: maximum density, minimum lot area, minimum side setbacks, and minimum parking requirements.

Density. The maximum allowed in much of this zone is 24 units per acre which enables 7 of the 9 MMH types and partially enables the Fourplex, Multiplex Small, Multiplex Large, and Courtyard.

Lot area. The minimum requirement is based on number of units, which may or may not be a problem, but is likely to preclude the feasibility of development on small- and medium-sized lots because the minimum areas are often larger than the existing lots in the zone, and can result in more land being required than necessary and feasible.

Side setback. The minimum required for multifamily projects is the greater of either 12 feet or 15 percent of the lot width. For infill lots less than 70 feet wide, this unnecessarily reduces the amount of building and will render development on small-sized lots unbuildable.

Off-street Parking. The minimum requirement for two-family homes (2 spaces per unit), for townhomes (2.25 spaces per unit), and for multi-family (starts at 1.5 spaces per unit) is a barrier especially to existing infill lots less than 100 feet wide.

- **Recommendation 15:** For MMH developments, do not regulate minimum lot area. Instead, regulate minimum lot width according to the needs of the different MMH types; Reduce side setbacks to what is required for single-family houses by considering setbacks for MMH types the same as for single-family houses because they're the same scale and footprint; For MMH developments within 1,000 feet of a walkable center, cap the required parking at 1 space per unit.

■ **RN-5:** This zone generally allows all 9 of the MMH types, but contains the following barriers: minimum lot size, minimum front setback, and minimum parking requirements.

Lot area. The minimum requirement is based on number of units, which may or may not be a problem, but is likely to preclude the feasibility of development on small- and medium-sized lots because the minimum areas are often larger than the existing lots in the zone, and can result in more land being required than necessary and feasible.

Front setback. The minimum requirement of 25 feet for multifamily developments is a barrier to lots less than 100 feet deep. For example, lots between 80 and 90 feet deep that could accommodate a Fourplex would

be at least 5 feet too shallow to comply with the requirement.

Off-street Parking. The minimum requirement for two-family homes (2 spaces per unit), for townhomes (2.25 spaces per unit), and for multi-family (starts at 1.5 spaces per unit) is a barrier especially to existing infill lots less than 100 feet wide.

- **Recommendation 16:** For MMH developments, do not regulate minimum lot area. Instead, regulate minimum lot width according to the needs of the different MMH types; Unless the context exists with deep setbacks, allow front setbacks of 15 feet; For MMH developments within 1,000 feet of a walkable center, cap the required parking at 1 space per unit.

Q CLOSER LOOK

Density Regulations on Infill Lots

While the Knoxville zoning code does not regulate density explicitly, density is effectively regulated by the minimum lot area requirements.

One of the primary purposes of facilitating the production of MMH types is to achieve sufficient density to support neighborhood amenities that are needed for true walkability. Keeping density low through minimum lot areas undermines this effort.

Whatever the approach, tying unit count to lot size ultimately favors large sites, not infill lots within existing blocks, resulting in the use of more land than what one building needs. The typical MMH type is on a lot that's the size of a lot for a single-unit dwelling.

Also, typical multi-family projects have multiple buildings and results in a density calculation that's lower than the single-lot, Missing Middle house-scale building. This might sound odd but it's because the more land you add to the calculation, the lower the density. Consider the two examples below:

- 21, 3-story buildings with a total of 502 units on a 53-acre site = 9.47 units/acre density

- 1, two-story, 8-unit Courtyard Building on a lot that is 100 feet wide by 120 feet deep = 29 units/acre density

These two projects are not similar in size, form or intensity. Yet, without seeing either, the 'density' number leads you to think that the lower

density number means fewer units, fewer buildings, and a smaller project. Though they might be nicely designed, the 3-story multi-family buildings are taller and at least twice the footprint of the MMH Courtyard Building.

It is important to keep in mind that the density regulations are set up to calculate 'units per acre', reflecting the origin of the tool to help forecast population and infrastructure needs for large areas of a community - or for entire communities. However, when applied to existing infill lots (e.g., less than 100 feet wide), the approach to regulating density needs to change along with the expectation that MMH on infill lots must conform to the current approach.

Development Standards

Density

- **RN-2:** Some of the parcels in this zone are in the Low-Density Residential designation, which allows up to 6 units per acre. This precludes all 9 MMH types, since the least intense type (Duplex) begins at 11 units per acre.
- **RN-3 and RN-4:** Some of the parcels in this zone are in the Medium-Density Residential designation, which allows up to 24 units per acre. This density can potentially be supportive of 5 of the 9 MMH types and partially supportive of 4 MMH types. However, given the intent of RN-4, 24 units per acre may be low to accommodate the envisioned new “limited nonresidential uses that are compatible with the character of the district.”
- **RN-5:** Some of the parcels in this zone are in the High-Density Residential designation (above 24 units/acre). This supports the full range of MMH types but it also supports development much more intense than MMH which could ultimately mean that MMH won’t happen because more intense development is allowed.

- **Recommendation 17:** For MMH developments, do not regulate density. Instead, regulate maximum building footprint, height, and parking. Alternatively, if density must be regulated, coordinate the maximum density in the zone to the selected MMH types and then for MMH types only, increase the maximum density allowed in the zone.

Lot Size/Area

Knoxville’s minimum lot area requirements differ by zone and by each of the four housing types that the code allows (i.e., single-family, two-family, townhouse, and multi-family). The minimum lot size requirement is a barrier to MMH primarily because existing lots that could accommodate MMH do not contain the minimum required amount of lot area. In order to meet the requirement, these lots would need to be assembled with adjacent lots to meet the requirement. While this might be possible some of the time, it is likely that it will not always be possible.

The second barrier here is that the minimum lot area is required by unit rather than by development type (for townhomes, and multifamily). This approach results in the lot size quickly becoming larger than the existing lots and buildings in the area, and can result in more land being required than necessary and feasible. This has an unpredictable result on the size and number of buildings, often resulting in larger buildings than exist in the area.

Lot “width” can be a more effective regulation than lot area because many projects can comply with the minimum lot area but still result in a building that is too large for its context. This often happens with low density housing like a Duplex that is allowed to fill up the building envelope and create a building that is within the density limits but is larger than nearby houses in the same neighborhood.

In contrast to this unpredictable approach, MMH types fit on lots as small as 4,000 square feet (40 to 50 feet wide by 100 feet deep) and include other types that fit on lots up to 15,000 square feet (100 feet wide x 150 feet deep). In all cases, the key metric to regulate here is Lot Width instead of Lot Area. See pages 32-33 for typical lot sizes by MMH type.

Figure 3.4

Minimum lot sizes required by zoning are often larger than necessary to enable MMH. For example, a Fourplex can function well on a 50-foot wide lot but typically is required to be on lots larger than necessary.

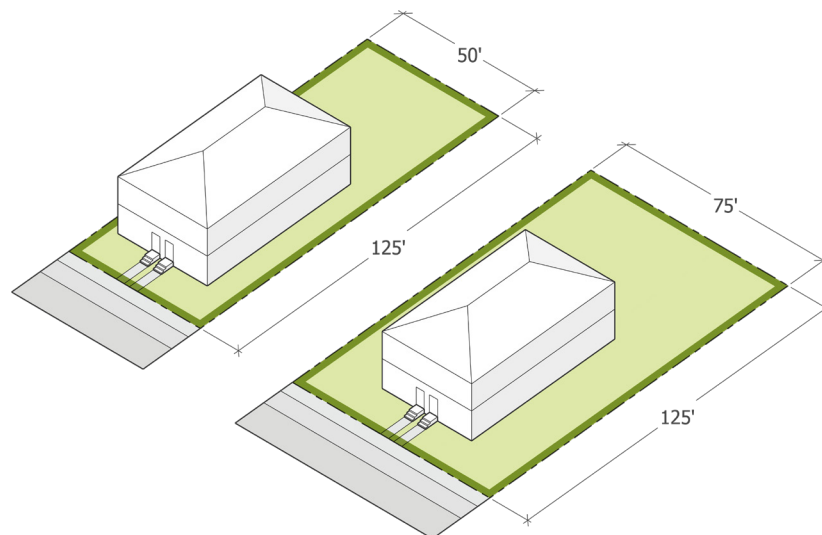

■ **RN-2:** This zone requires a minimum 15,000 square feet of lot area for a two-family dwelling (Duplex), which translates into 5.8 du/acre. As mentioned above, most MMH types do not need 15,000 square feet to function. This zone does not allow Townhouses and multi-family development.

- **Recommendation 18:** For MMH development, do not regulate lot area. Revise the lot width requirement to be coordinated with the selected MMH types to be allowed in this zone.

■ **RN-3:** This zone requires a minimum 7,500 square feet of lot area for a two-family dwelling (Duplex), which translates into 11.6 du/acre. This minimum amount of lot area works well for other MMH types (Triplex/Fourplex and Multiplex Small). The zone allows for Townhouses by Special Use Approval, but requires lot size by unit. This zone does not allow multi-family development.

■ **RN-4:** This zone requires a minimum of 7,000 square feet for a two-family dwelling (Duplex), which translates into 12.4 du/acre. Townhomes require 3,000 square feet of lot area per unit, which translates into 14.5 units/acre. Multifamily developments require 2,000 square feet for lot area per unit, which translates into 21.8 units/acre. This is still below the upper end of the intended density of the Medium Density Residential future land use designation. Duplexes, Triplex/Fourplexes, and Townhomes can work on lots that are 7,000 and smaller.

■ **RN-5:** This zone requires a minimum lot area of 5,000 square feet for a two-family dwelling (Duplex), which translates into 17.4 du/acre.

We have found that both Duplex types can work on this sized lot, with or without an alley. Townhomes are allowed and require at least 2,000 square feet of lot area per unit.

Multifamily developments require 2,000 square feet of lot area for the first two units, and then 1,450 square feet of lot area for each unit thereafter. This means that a Fourplex needs 6,900 square feet and a Multiplex Small with 6 units would need 9,800 square feet to be allowed in this zone. Our experience shows that a Fourplex fits well on a 5,000 square foot lot and a Multiplex Small (6 units) fits well on a 6,000 to 7,000 square foot lot.

- **Recommendation 19:** For MMH developments, do not regulate minimum lot area. Revise the lot width requirement to be coordinated with the selected MMH types to be allowed in this zone.

Parking

Knoxville’s residential parking requirements differ by the four housing types that the code allows (single-family, two-family, townhomes, and multi-family). Two-Family and townhome developments both require two on-site spaces per unit, with townhomes requiring additional visitor parking. Multifamily developments require between 1 and 2 spaces per unit, depending on the number of bedrooms, plus additional visitor parking. These requirements are understandable for typical multifamily development that isn’t in a walkable neighborhood (see Sidebar on page 38 about Walkable Neighborhoods). But for MMH development, a different approach is needed.

Generally, because MMH types are within short walking distance of amenities, there isn’t a need for more than one on-site space per unit. Where more than one space per unit is provided, site design can be challenging primarily because the typical MMH lot is the same size as most single-family lots and only so much parking can physically fit. Certainly, an adjacent parcel or a portion of an adjacent parcel can be purchased to add to a MMH parcel but this approach can be very

unreliable and it tends to make projects and buildings larger than anyone expected because of the additional cost to purchase extra land.

The code provides relief from the parking standard through a 30 percent decrease in the number of required on-site spaces for parcels within ¼ mile of a transit route. On a parcel that can accommodate 6 units but is required to have 12 parking spaces, this means a reduction of 3.6 spaces. Assuming that rounding up isn’t allowed, the adjusted requirement is 9 spaces. However, if the requirement were simply reduced to one space per unit, the building could accommodate 9 units. The code also provides for additional parking flexibility upon the approval of a parking study by the Department of Engineering. Although this is an option, it’s not a realistic option for small-scale developers due to the cost and complexities of preparing such a study.

Figure 3.5

Parking has a significant impact on MMH and affordability. This illustration shows how much more space is required to fit a Fourplex on a lot when 2 spaces are required per unit (far right) versus 1 space per unit (right).

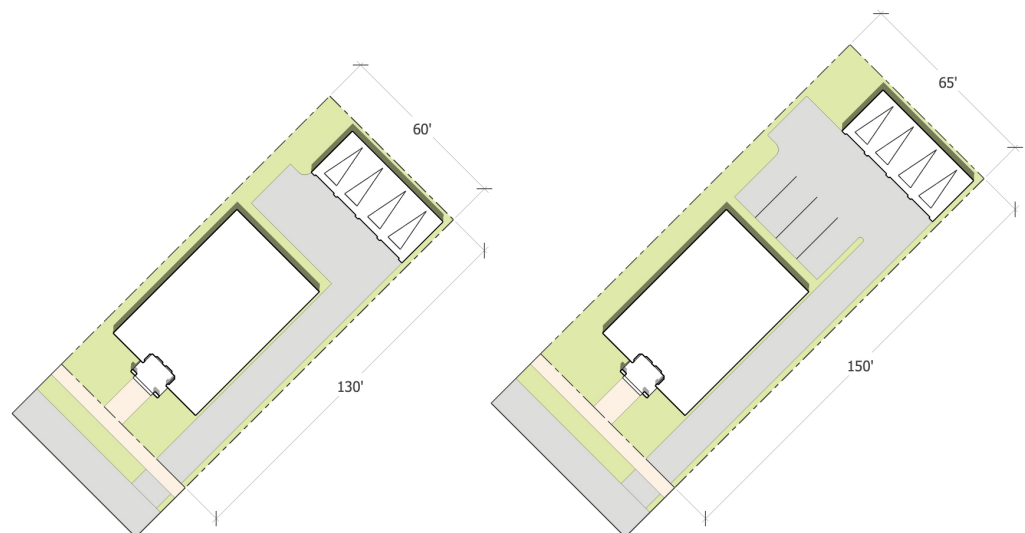

- **Recommendation 20:** For MMH developments within ¼ mile of a transit stop, or any combination of shops, services, food uses, revise the requirement for off-street parking to a maximum of one space per unit. For MMH developments within ¼ mile of a transit stop with service every 15 minutes or less, eliminate the requirement for off-street parking entirely.

The code currently requires that parking areas for multifamily developments be set ten feet away from rear or interior side property lines that abut single-family districts. This approach works very well on larger sites where larger parking areas are understandably expected to be screened and buffered from adjacent houses. But on the typical MMH lot, this requirement can reduce the ability to provide required off-street parking which in turn, reduces the number of housing units that can be produced.

- **Recommendation 21:** For MMH developments, revise the setback to five feet to allow for a landscape planter between the parking space and the adjacent lots.

Building Setbacks

- **Front Setbacks.** Current front setback requirements do not pose barriers and are supportive of MMH in 3 of the 4 zones analyzed. However, the RN-5 zone – the most intense of the zones analyzed – requires a 25-foot front setback which could present issues for lots less than 150 feet deep that are expected to generate more than 5 units.
- **Side Setbacks.** Current side setback requirements do not pose barriers and are supportive of MMH in 3 of the 4 zones analyzed. However, in the RN-4 zone, Multifamily projects require interior side setbacks of 12 feet or 15 percent of the lot width (whichever is greater). This standard is a typical approach for apartment projects on large sites where such a buffer might be desirable. For MMH development, this requirement is a barrier on lots less than 75 feet wide because it reduces the potential width of the building.
- **Rear Setbacks.** Current rear setback requirements are 25 feet in all of the zones analyzed. For lots 100 feet or deeper, this is not a barrier. For lots less than 100 feet, this deep setback presents challenges on site planning. We have found that rear setbacks between 15 and 20 feet are more appropriate. The required deep rear setback may inadvertently preclude feasible site design on shallower lots that are otherwise workable.
- **Recommendation 22:** For MMH developments, allow parking within rear setback.

Lot Coverage

The maximum lot coverage in the four zones studied here is between 30 and 35 percent. Depending on the lot size, this may or may not be a barrier to MMH. The main concern with the maximum lot coverage approach is that it does not prevent buildings that may be out of scale with neighboring buildings. We find the most direct way to avoid that outcome is to control building footprint as well as height – but most importantly footprint.

- **Recommendation 23:** Replace lot coverage requirements for MMH developments with maximum building footprint and height requirements to ensure house-scale buildings.

Building Height

MMH types range in height from 1 to 2.5 stories (0.5 stories indicates an attic story), or about 30 to 35 feet overall in height. Building height is not a barrier in any of the four zones analyzed. However, the RN-4 zone allows up to 45 feet for multifamily developments, which is likely to be out of scale with the intended development pattern and therefore cause projects to meet neighborhood resistance.

- **Recommendation 24:** Where MMH is expected in the RN-2, RN-3, and RN-5 zones, clarify that within the maximum 35 feet overall building height, that only allow 2 or 2.5 stories are allowed instead of 3 stories which could technically fit. Also, clarify that where the RM-4 zone is adjacent to areas of MMH or single-family development, the maximum overall height of 45 feet for multifamily developments only be allowed for Upper MMH.

Residential Uses Permitted

The use allowance is the most obvious barrier to MMH identified in this Scan. Each of the four zones studied in this Scan allows one or more of the following housing types: single-family, two-family, townhomes, and multi-family.

- The RN-2 zone requires a Special Use Permit (SUP) for two-family developments and prohibits townhomes and multifamily developments.
- The RN-3 zone allows two-family developments by right, but requires a SUP for townhome development. Multifamily developments are prohibited.
- The RN-4 zone contains more nuanced use standards:
 - Allowed by right: two-family developments, townhome developments with up to 8 units, multifamily buildings up to four units, and multifamily developments up to 4 units per building and up to 8 units on the lot.
 - Allowed with SUP: townhome developments with more than 8 units, multifamily buildings with more than four units, and multifamily developments with more than 8 units on the lot.
- The RN-5 zone allows all identified housing types by right.





- **Recommendation 25:** For MMH development, allow all MMH types by right if clear standards are applied to control building height, footprint, parking and parking location, building entry/frontage, and streetscapes. Development that does not use these standards would be required to go through the special use process.

































3.3

Summary of Barriers

The table below summarizes Section 3.2 to graphically represent the various types of barriers to MMH within the Knoxville Zoning Code and which of the nine MMH types are possible under the current zoning regulations.

Key

-  Enables All MMH Types
-  Barrier to 3 or fewer MMH Types
-  Barrier to 4 or more MMH Types
-  Unclear/Potential Barrier
- (# of 9) Standard enables "#"
MMH Types

Summary of Regulatory Barriers for Housing in Knoxville				
Development Standards				
	RN-2	RN-3	RN-4	RN-5
Density Maximum	 (0 of 9)	 (7 of 9)	 (7 of 9)	
Lot Area Minimum	 (0 of 9)			
Lot Width Minimum		 (6 of 9)	 (8 of 9)	
Setbacks Minimum				
Front Setback				
Side Setback				
Rear Setback				
Lot Coverage Maximum				
Open Space Minimum				

Summary of Regulatory Barriers for Housing in Knoxville				
Development Standards				
	RN-2	RN-3	RN-4	RN-5
Building Height Maximum	✓	✓	✓	✓
Permitted Residential Uses (MMH Types)	✗ (0 of 9)	✗ (2 of 9)	● Enables some multifamily ¹	✓
Parking/Driveway Standards				
	RN-2	RN-3	RN-4	RN-5
Min. Parking Spaces per Unit	✗ Too high ²	✗ Too high ²	✗ Too high ²	✗ Too high ²
Min. Driveway Width	✓	✓	✓	✓

¹Up to 4 units are permitted by right in one building and up to 8 units are permitted on one lot. Unit count may exceed this, but requires Special Use Permit.

²Parking minimums are required by housing type. Two-Family dwellings require 2 per unit, Townhouse dwellings require 2.25 per unit, and Multifamily dwellings require parking based on the number of bedrooms: studio and one-bedroom units require 1.2 spaces, and the minimums go up from there. A requirement of more than one on-site parking space per unit is generally considered a barrier to MMH.

3.4 Allowed Density

Allowed Density

According to the maximum allowed density, the RN-3 and RN-4 zones enable 7 of the 9 MMH types (all but the Multiplex Small and Multiplex Large). No MMH types are enabled in the RN-2 zones because the current density limit is too low. However, simply increasing the maximum allowed density could create other issues such as large buildings that are not contextually appropriate for their neighborhood.

Increasing the maximum allowed density needs to be coordinated with carefully identifying the appropriate MMH building types for Knoxville's different areas and then incorporating the resultant density range of those types along with standards for maximum building footprint and lot width.

- Key**
- Range of MMH Type
 - Range Enabled by Zoning
 - MMH Type Enabled
 - MMH Type Partially Enabled
 - MMH Type Not Enabled

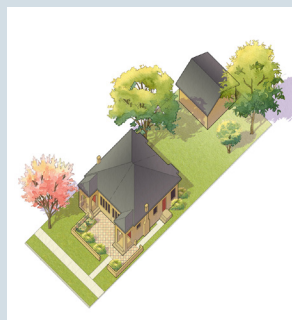

Duplex Side-by-Side

11-17.4 du/ac



Duplex Stacked

13-25 du/ac

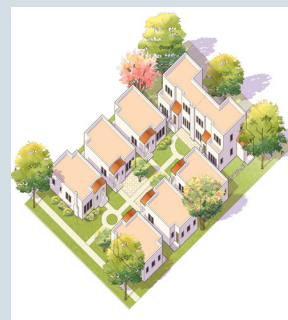

Cottage Court

15-19 du/ac



Triplex/Fourplex

20-29 du/ac

Land Use Classifications and Density Limits:

Low Density Residential

< 6 du/ac¹

Applies to RN-2

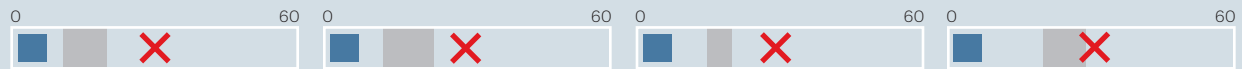

Medium Density Residential

6 - 24 du/ac¹

Applies to RN-3 & RN-4



High Density Residential

> 24 du/ac¹

Applies to RN-5



¹Except parcels in the TDR or MDR/O land use classifications, which do not have a density limits.

MMH Types Enabled by Current Density Standards

The chart below shows which and how much of each MMH type is enabled in each zone based on the maximum allowed density. When the gray and blue bars do not overlap, that MMH type is not enabled. The densities shown in this table result from the lot and width and depth scenarios on pages 32 and 33. The densities will decrease or increase depending on the actual lot width and depth applied.

- **Recommendation 26:** Increase the maximum allowed density for MMH types based on the lot size needs of each MMH type; or
- **Recommendation 27:** Do not regulate density. Instead, regulate MMH using building types with clear footprint and unit limits.

Depending on the support for changing existing zoning, the MMH types and their standards could be adopted as new zoning or as an overlay that only applies to identified walkable neighborhoods.



Multiplex Small
33.2-44.6 du/ac

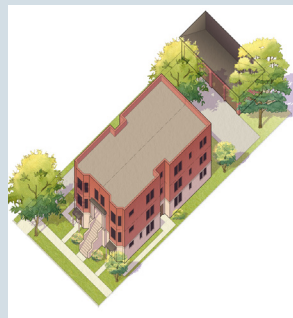

Multiplex Large
37-55.3 du/ac



Courtyard Building
18-46.5 du/ac



Townhouse Small
16-17.5 du/ac



Townhouse Large
18.6-55.8 du/ac

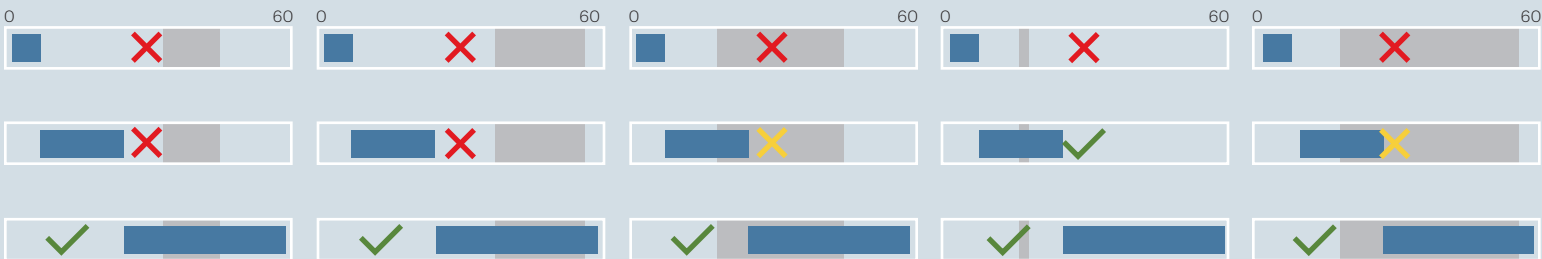

3.5 Minimum Lot Width

Importance of Lot Width

Knoxville’s minimum lot width requirements differ by zone and by each of the four housing types that the code allows (i.e., single-family, two-family, townhouse, and multi-family). Two-family buildings require 50 feet of lot frontage, townhouses require 20 feet of lot frontage per unit, and multifamily developments require 60 feet of lot frontage.

While several of the MMH types can be accommodated on smaller lots – especially on blocks with alley access – the minimum width required for multifamily (e.g., 3 or more units) is a barrier. For example, MMH Triplex/Fourplex and Multiplex Small (up to 6 units) types fit well on a lot that is 50 feet wide, ten feet less than the required 60 feet.

- **Recommendation 28:** For MMH developments, revise the lot width requirement to be coordinated with the selected MMH types to be allowed in this zone.

The Palette of Missing Middle Housing Types with Typical Lot Width Range

The palette of MMH types is provided for reference to the typical lot width range of each type. These lot width ranges include rear-loaded lots.



Duplex Side-by-Side
45' - 55'



Duplex Stacked
45' - 50'



Cottage Court
105' - 115'



Triplex/Fourplex
45'-60'

MMH Types Enabled by Current Lot Width Standards

The gray bars show the typical lot width range for each MMH type based on front or rear vehicle access. Each zone's minimum lot width standard is shown horizontally by a dashed line to illustrate which MMH types, and how much of each, are possible.

- **Recommendation 29:** Coordinate each MMH type with the existing lot sizes in the areas where MMH is intended. Then, apply this information to each relevant zone.

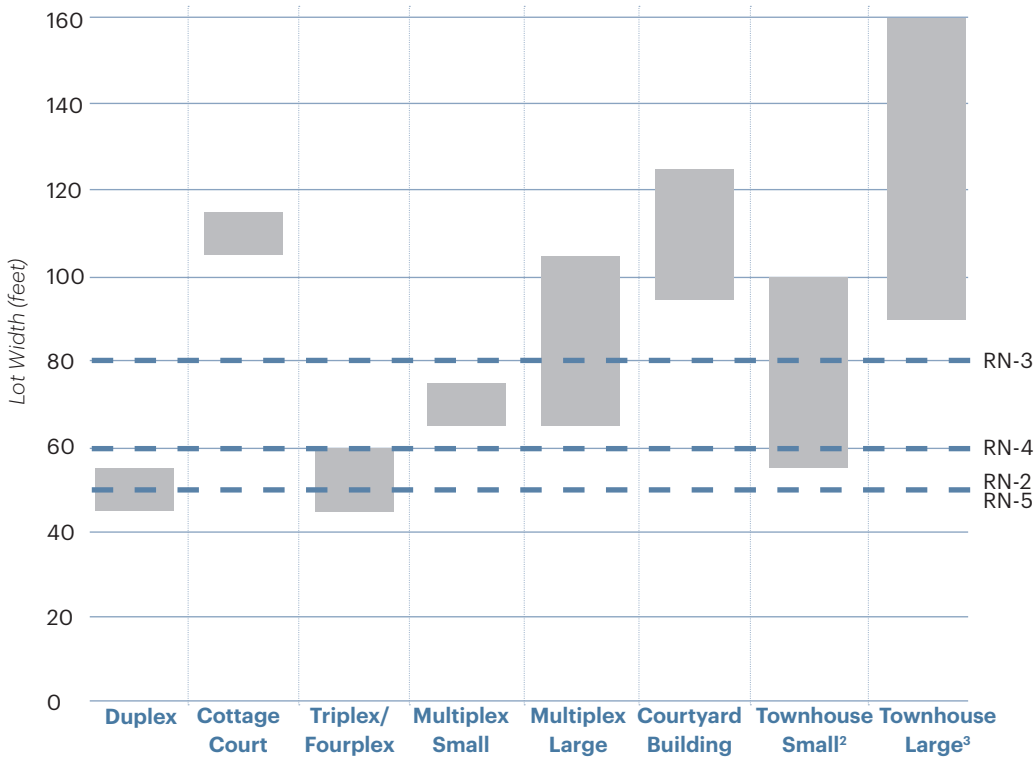

Key

■ Typical MMH Lot Width Range for Front-loaded and Alley-loaded lots (minimum to maximum)

Minimum Required Lot Widths by Zone

- RN-2 (min. 50 ft)
- RN-3 (min. 80 ft)¹
- RN-4 (min. 60 ft)
- RN-5 (min. 50 ft)

¹ Minimum lot width for 4 Townhouse units in a row (20 feet min per unit).

² Reflects the width for a group up to 4 Townhouse units in a row including 5-10 feet side setbacks for the group.

³ Reflects the width for a group of up to 8 Townhouse units in a row including 5-10 feet side setbacks for the group.



Multiplex Small

65' - 75'

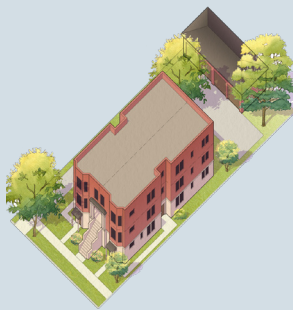

Multiplex Large

65' - 105'



Courtyard Building

95' - 125'

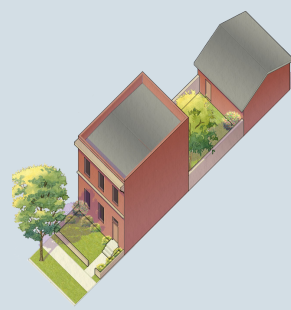

Townhouse Small

18'-25' (single unit)
54'-100' (3-4 units in a row)

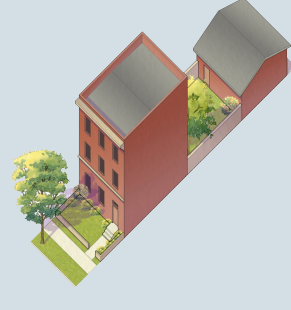

Townhouse Large

18'-25' (single unit)
90'-200' (5-8 units in a row)

3.6

Next Steps

Additional Recommendations for Implementing MMH

This MMH Scan™ (Analysis + Definition of Barriers to MMH) is the first of a two-part analysis and focuses on identifying barriers to MMH. If selected, the second part, MMH Deep Dive™ (Testing + Solutions for MMH) is a more detailed analysis of Knoxville's zoning to test-fit MMH types.

Part 2:

- Tests the existing zoning in walkable contexts on a variety of selected existing infill parcels to identify the number of dwellings allowed and the maximum building size under two scenarios:
 - Existing zoning, and
 - Existing physical conditions without limitation by existing zoning but within the context of the neighborhood. In other words, which MMH type(s) would fit well if allowed?
 - The above results are intended to provide further insight about recommended improvements and changes to existing standards.
- Identifies detailed recommended changes to zoning standards.

If Part 2 is not selected, we recommend the following:

- Work with the community and developers to understand the value of MMH and the findings and recommendations of this MMH Scan™.
- Prioritize MMH within the 5 to 10-minute walkable environments around the existing Walkable Centers.
- Apply the findings of this MMH Scan™ to the zoning within the 5 to 10-minute walkable environments around the existing Walkable Centers.
- Prioritize testing/fitting the desired MMH types to the actual lot sizes in specific walkable environments to identify additional changes needed to existing standards beyond those already recommended in this Scan.
- Work with the community and developers to determine which of the current Auto-oriented Centers are ready to transform into Walkable Centers, making the surrounding parcels "MMH-Ready" environments.
- If changing the standards of the RN-2, RN-3, RN-4, and RN-5 zones only where MMH developments are expected is not practical, enable MMH through a new MMH zone and standards, or through a set of overlay standards.

Current Zoning within Walkable Environments (Existing and Potential)

The map shows the location of the four zoning districts analyzed in relation to the existing Walkable Centers and Corridors and Potential Walkable Centers and Corridors in MMH-Ready environments identified through this analysis.

Figure 3.6 Location of four zoning districts analyzed and Walkable environments (Existing and Potential)

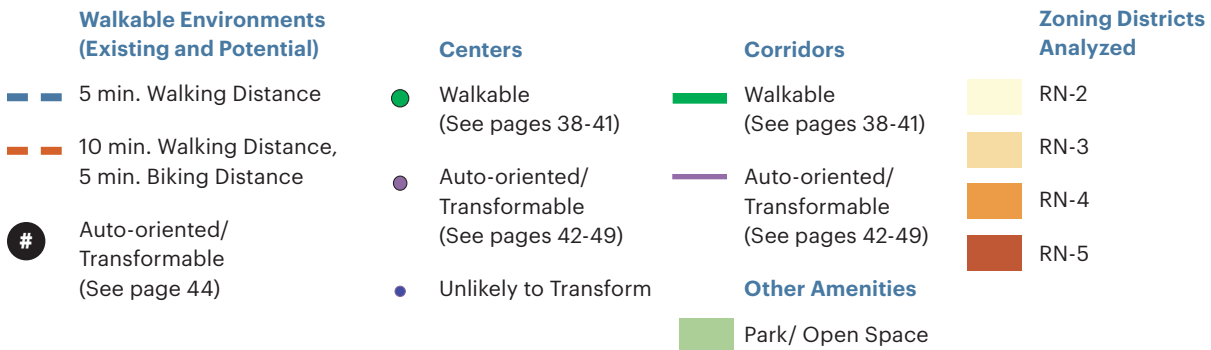
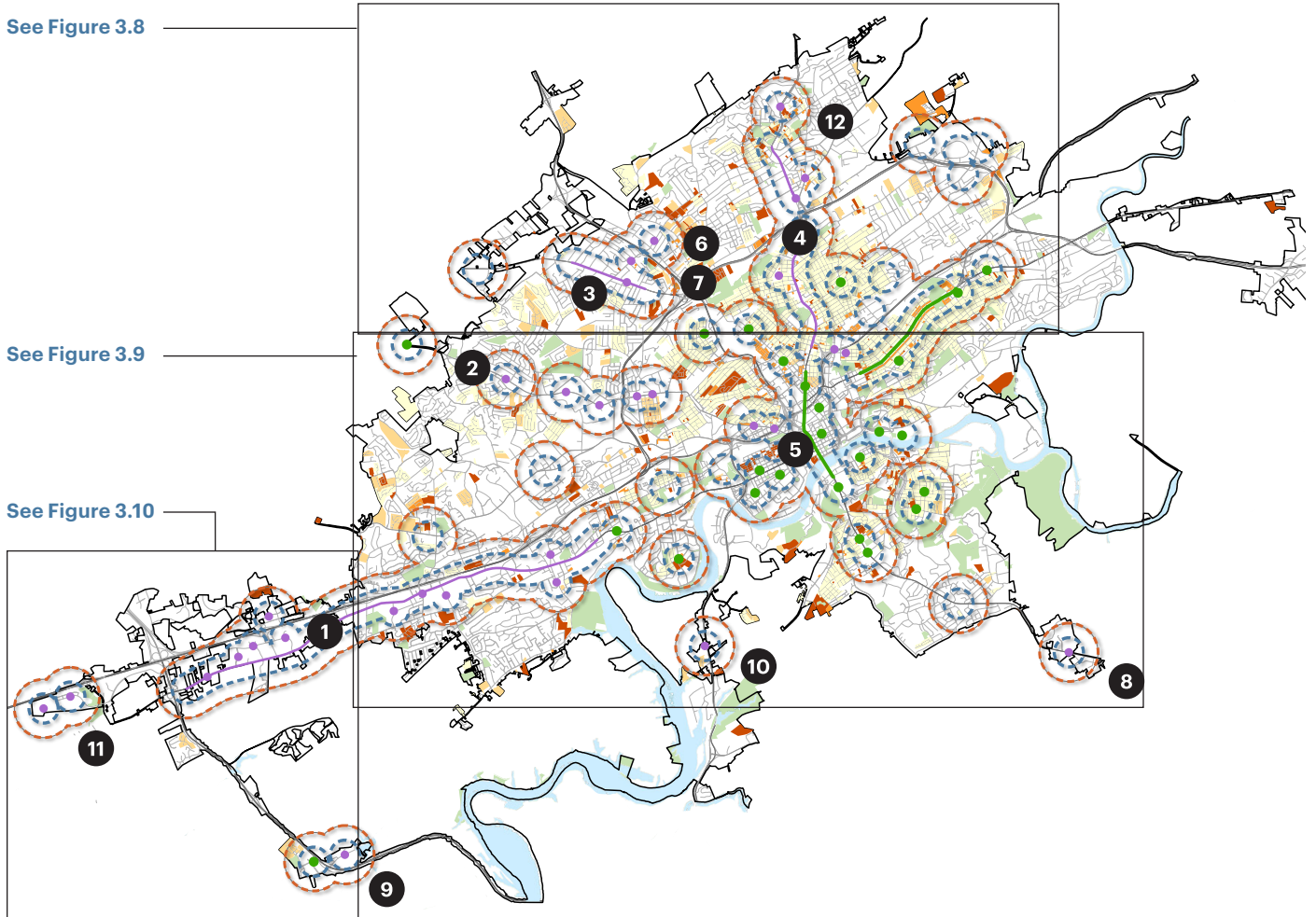

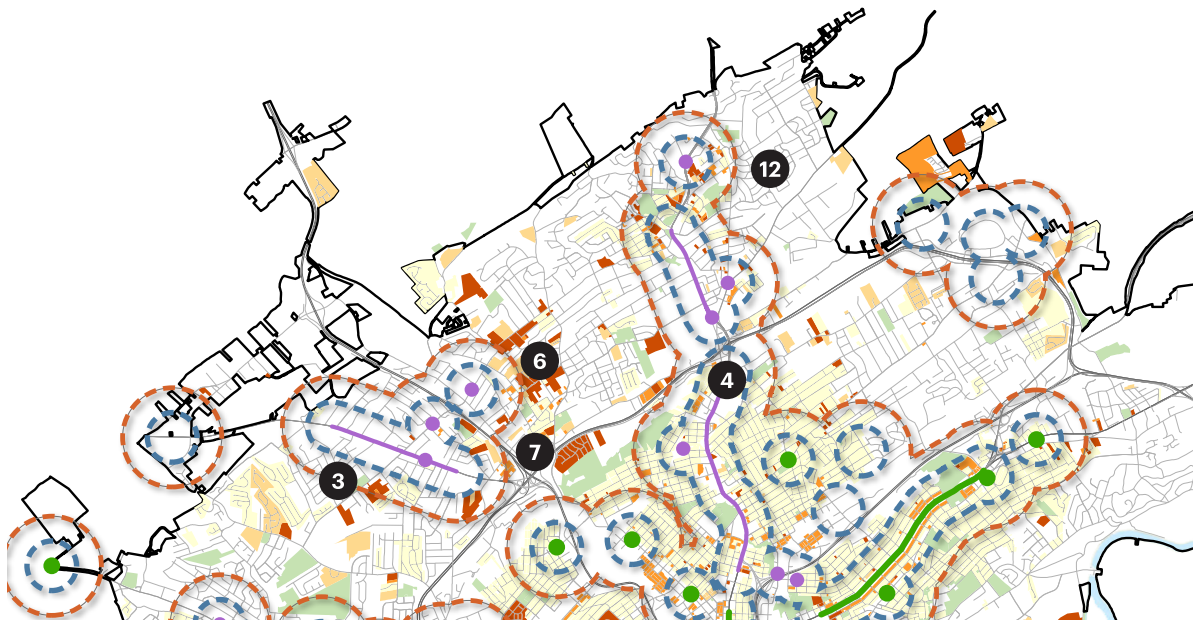
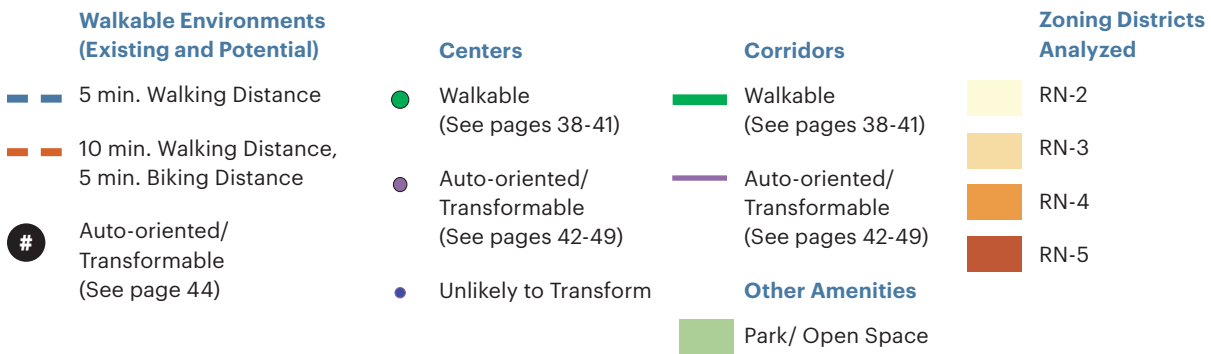

Figure 3.7 North Knoxville



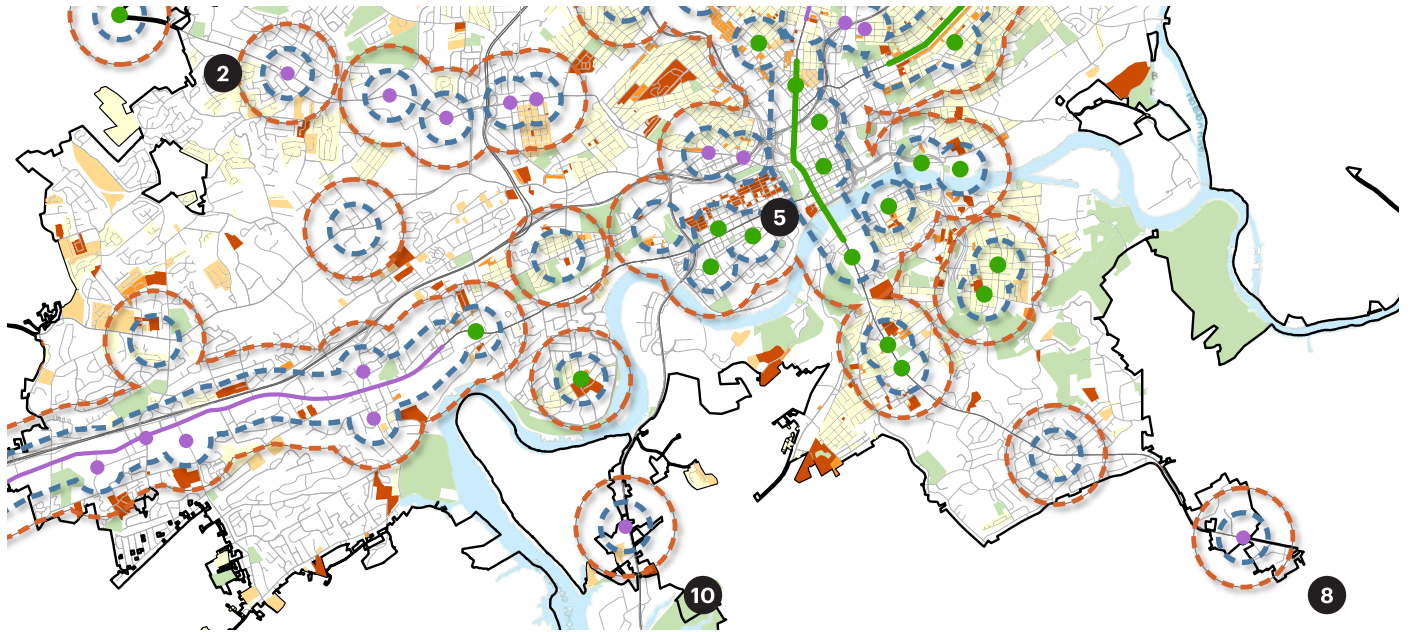

Figure 3.8 Central Knoxville

